



## The Collections '23



**DRENCH**  
INSPIRE BY DESIGN

### Metallic Finishes



LB	<b>Light Bronze</b>	Anodised
DB	<b>Dark Bronze</b>	Anodised
BS	<b>Brushed Steel</b>	Anodised
BB	<b>Brushed Brass</b>	Anodised

### MATTE Colours

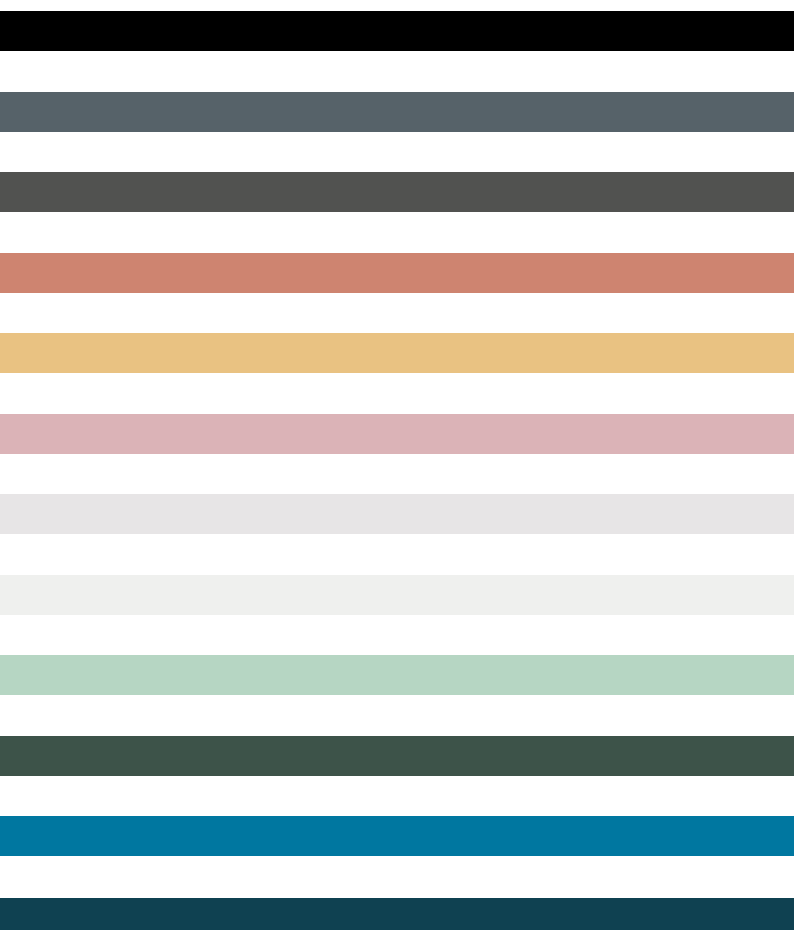









BK	<b>Matt Black</b>	RAL 9005
GG	<b>Graphite Grey</b>	RAL 7024
GM	<b>Gun Metal</b>	RAL 8019
BO	<b>Burnt Orange</b>	RAL 3022
LY	<b>Lemon Yellow</b>	RAL 1012
PP	<b>Pale Pink</b>	RAL 3015
BL	<b>Blanc</b>	RAL 9002
TT	<b>Total White</b>	RAL 9003
MI	<b>Mint</b>	RAL 6019
FO	<b>Forest</b>	RAL 6009
CB	<b>Capri Blue</b>	RAL 5019
GN	<b>Grey Navy</b>	RAL 5008

# Contents

ABOUT US .....	2-3
CE DECLARATION OF PERFORMANCE .....	4-5
PRODUCT FEATURES .....	6-7
ABOUT OUR GLASS .....	6
ABOUT OUR METAL .....	7
PRODUCT CONFIGURATIONS .....	8-9
MATTE COLOURS .....	10-11
METALLIC FINISHES .....	12-13

## THE COLLECTIONS '23

	<b>EDGE</b> Collection .....	16-21
	Semi-frameless Panels .....	
	<b>FRAME</b> Collection .....	22-27
	Fixed Panels .....	
	<b>HEXAGON</b> Collection .....	28-33
	Fixed Panels .....	
	<b>FRAME Lite</b> Collection .....	34-65
	Fixed Panels .....	38-39
	Fixed Panels with Flipper .....	40-41
	Free Standing Panels .....	42-43
	Bath Screens .....	50-51
	Shower Doors & Enclosures .....	54-55
	Shower Door with Inline & Enclosures .....	56-57
	Shower Door hinged to Inline & Enclosures .....	58-59
		<b>MATTE Colours</b> .....
		<b>Metallic Finishes</b> .....
	<b>SUZHOU</b> Collection .....	66-97
	Fixed Panels .....	70-71
	Fixed Panels with Flipper .....	72-73
	Free Standing Panels .....	74-75
	Bath Screens .....	82-83
	Shower Doors & Enclosures .....	86-87
	Shower Door with Inline & Enclosures .....	88-89
	Shower Door hinged to Inline & Enclosures .....	90-91
		<b>MATTE Colours</b> .....
		<b>Metallic Finishes</b> .....
	<b>DECO</b> Collection .....	98-129
	Fixed Panels .....	102-103
	Fixed Panels with Flipper .....	104-105
	Free Standing Panels .....	106-107
	Bath Screens .....	114-115
	Shower Doors & Enclosures .....	118-119
	Shower Door with Inline & Enclosures .....	120-121
	Shower Door hinged to Inline & Enclosures .....	122-123
		<b>MATTE Colours</b> .....
		<b>Metallic Finishes</b> .....
	<b>BORDER</b> Collection .....	130-161
	Fixed Panels .....	134-135
	Fixed Panels with Flipper .....	136-137
	Free Standing Panels .....	138-139
	Bath Screens .....	146-147
	Shower Doors & Enclosures .....	150-151
	Shower Door with Inline & Enclosures .....	152-153
	Shower Door hinged to Inline & Enclosures .....	154-155
		<b>MATTE Colours</b> .....
		<b>Metallic Finishes</b> .....
	<b>TOUCHES</b> Collection .....	162-171
	Shower Doors & Enclosures .....	166-167
	Shower Door with Inline & Enclosures .....	168-169
	Shower Door hinged to Inline & Enclosures .....	170-171
	<b>BASE</b> Shower Trays Collection .....	172-175
	BESPOKE & MADE TO MEASURE .....	176-177
	ACCESSORIES & PARTS .....	178-185
	MAINTENANCE & CLEANING .....	186-187
	WARRANTY TERMS & CONDITIONS .....	188

# About us

DRENCH SHOWERS is a British Manufacturer of Shower Doors & Enclosures distinguished by the wide selection of colours, finishes and glass options that match the latest market trends.

The Bathroom is no longer the place where you just wash your hair. For years and years, bathroom design was overlooked as it did not seem to be a picturable room.

Nowadays, social media and sites like Instagram or Pinterest have changed that trend and inspired people to think of their bathroom as an area to express personality through creative design.

At DRENCH we understand where trends are moving and we are here, not to follow but to lead you to our true design expression. Innovation along with meticulous design and quality manufacture have resulted in this superior range of products.

Whether standard or made to measure products, DRENCH puts forward that many options, you can be confident in thinking your shower enclosure is unique and unrepeated.

Combinations and possibilities are endless.

The only limitation is your imagination.

***Black is still in vogue  
but now DRENCH can lead you  
to your true design expression.***



Our drivers of sustained values;



### ***Innovation***

We aim for innovation on our products and processes. We pursue differentiation and creating a leap in value for both the customer and the company.



### ***Quality***

We ensure the best components and materials are used on our products to guarantee a correct performance and long durability. Meeting and exceeding all requirements, standards and specifications is our ultimate goal.



### ***Integrity***

We say what we mean and we mean what we say. We commit to treat everyone equitably and communicate openly and honestly.



### ***Customer Service***

We dedicate our efforts to uncovering and meeting customer needs, delivering excellent service and incorporating customer feedback into product design and other business decisions.

# Made in the UK



DRENCH products are manufactured on our premises in Hursley, Winchester.

**DRENCH manufacturing technique has a patent granted GB2562114 and named Hygienic Decorative Bathroom Partition in accordance with Patents Act 1977.**

All DRENCH products have been carefully designed using the best quality raw materials. Sourced locally and tested by our team in accordance to British Standards BS EN 14428:2015 as per declaration of performance included in this catalogue.



# UK CA

Since the UK left the EU, product marking rules changed and the UKCA (UK Conformity Assessed) came to force.

DRENCH shower panels and enclosures conform to British Standards requirements of the mandate given under **EU Construction Product Directive (EU) 305/2011**.

Testing was carried out under scope of System 4 which allows self-declaration of conformity for UKCA.

UK/CE Mark are included on both packaging and assembly instructions in all DRENCH products as well as available to be downloaded from our website.

[www.drenchshowers.co.uk/company/](http://www.drenchshowers.co.uk/company/)



**EC Declaration of Performance**

*In accordance with BS EN 14428:2015*

**We:**

DRENCH EUROPE LTD, Unit 5 & 6 Deer Park Farm, Hursley Road, Hursley, Hampshire, SO21 2LD

**Declare that:**

The following product range:

Product Range	Shower Screens & Shower Enclosures
Product Styles (Collections)	FRAME, FRAME Lite, DECO, LINEA, BORDER, SUZHOU & HEXAGON
Product Configurations	Wall Fixed Panels, Free standing panels, Fixed panels with Flipper panel, Bath Screens, Shower Doors, Shower Doors with Inline panel & Shower Enclosures.

**In accordance with the following Directives:**

- Mandate M/110<sup>2</sup>
- EU Construction Products Regulations (89/106EEC)

**Fully conform to the scope and relevant characteristics from Annex ZA:**

BS EN 14428:2015 Shower Enclosures – Functional requirements and test methods

**Table ZA.1 – Scope and relevant clauses for shower enclosures**

<b>Construction Product:</b>	Shower enclosure		
<b>Intended use:</b>	Personal hygiene		
<i>Essential Characteristics</i>	<i>Requirement clauses in this EU Standard</i>	<i>Mandated Levels and/or Clauses</i>	<i>Notes</i>
Cleanability	4.2	None	Pass
Impact resistance/shatter properties	4.3	None	Pass
Durability	4.4	None	Pass

**Table ZA.2 – System of attestation of conformity**

Product	Intended Use	Level (s) or class (es)	Attestation of conformity system
Shower Enclosures	Personal hygiene	-	4
System 4: See 89/106/EEC (CPR), Annex III.2 (ii), third possibility			

**Table ZA.3 – Assignment of evaluation of conformity tasks**

Tasks		Content of tasks	Evaluation of conformity clauses to apply
<b>Task for the manufacturer</b>	Initial Type testing	All relevant characteristics of Table ZA.1	7.2
	Factory production control	Parameters related to all relevant characteristics of Table ZA.1	7.3

I hereby declare that our shower enclosures have been tested and fully conform to the scope and relevant characteristics of BS EN 14428:2015 to meet the requirements of Mandate M/110<sup>2</sup> and EU Construction Products Regulations (89/106EEC)

**Signed by:**

Guillermo Rubio (Director)

**Date:** February 2018



# Product Features

## About Our Glass

DRENCH products are manufactured using the highest quality of Safety Glass, Toughened in compliance with **BS EN12150-1-2015**.

All standard products shown in this brochure are manufactured using 8 mm Toughened Clear/Float glass. **Cross Fluted, Fluted, Frosted and Grey Tinted glass** are also available with an extra surcharge.



DRENCH products are treated with a special coating, know as Enduroshield, applied on the internal face of the shower to allow for easy clean.



*Enduroshield for Glass is an optically clear liquid that is sprayed onto glass and chemically bonds to the surface creating a non-stick barrier resistant to corrosion, etching and staining. However, while cleaning is made easier and less frequent, the need to clean is not eliminated.*

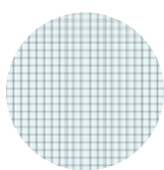
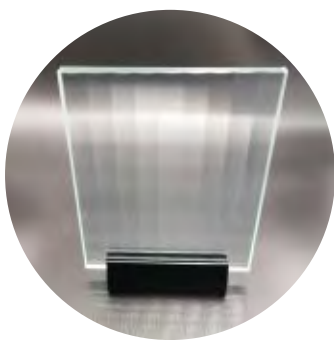

**Cross Fluted**  
8.8 mm TGH  
Laminated

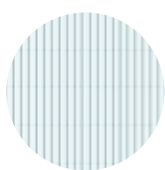
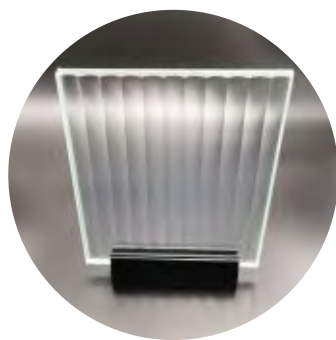

**Fluted**  
8.8 mm TGH  
Laminated

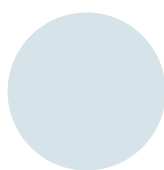

**Frosted**  
8 mm TGH  
Satin Etch

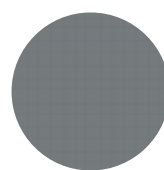

**Grey Tinted**  
8 mm TGH  
Smoked glass

Impactful as well as elegant, Cross fluted is a Clear but semi-transparent glass with intersecting vertical and horizontal reeds creating a fine texture made of little concave squares.

Glass inside the shower area is completely smooth allowing your screen to be easily cleaned.

Our classic Fluted glass adds the vintage chic look and the visual interest to your Shower area. It improves the privacy by creating subtle shifting of light .

Glass inside the shower area is completely smooth allowing your screen to be easily cleaned.

Frosted is Our most opaque glass option. External side of the glass is satin etched to create the frosted effect.

The satin etch process creates a permanent decorative texture that is also scratch and fingerprint resistant.

Internal side is completely smooth to be easily cleaned. .

Smoked grey glass that gives a delicate look to your screen. The grey tint on the glass brings privacy and elegance.

Both glass inside and outside the shower area is completely smooth allowing your screen to be easily cleaned.

# About Our Metalwork

DRENCH metalwork is made of Aluminium alloy 6060 grade. Aluminium is the perfect material for Shower screens as it can be extruded into complex shapes, it is mechanically strong and does not rust.

All DRENCH profiles have been specifically designed to offer a wide range of products from Wall Fixed panels, Bath Screens and the most complex range of Shower Doors and Enclosures.

DRENCH products are manufactured using different systems depending on the collection:



**EDGE System**

EDGE system is the technique used for our Semi frameless range of panels. The system is based on a toughened piece of glass attached to the wall using a wall profile and a gasket. System used on **EDGE Collection** Panels.



**FOLD System**

The FOLD system is based on the use of a full aluminium sheet laser cut and bonded to the glass folding on the edge and creating perfectly smooth corners. System used on **FRAME Collection** Panels.



**LITE System**

The LITE system is based on a piece of glass fully framed with our own profiles and laser cut pieces of aluminium bonded in the front face of the glass, recreating the chosen pattern. System used on items from **FRAME Lite, DECO, SUZHOU, HEXAGON, BORDER and TOUCHES Collection.**

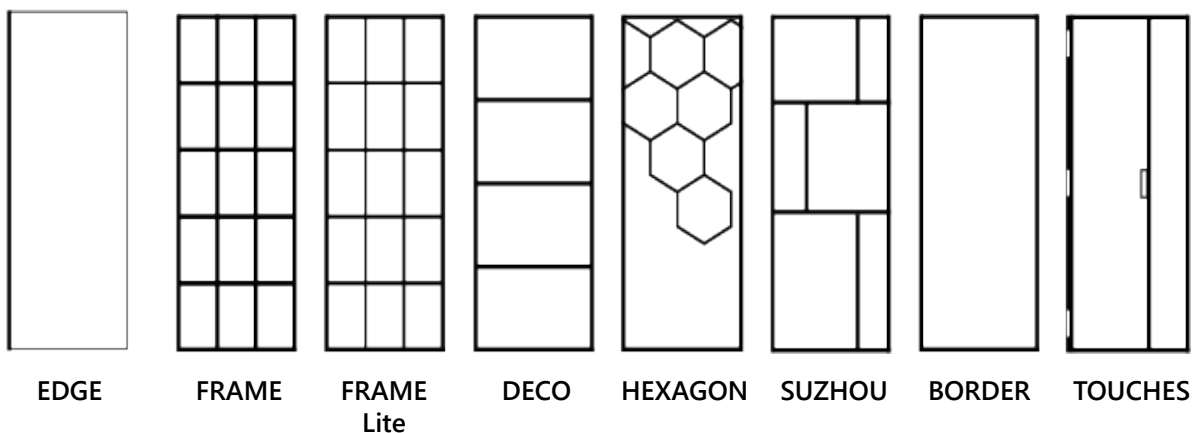

# Product Configurations

DRENCH product portfolio comprises a variety of standard glazing configurations for your shower area. Starting from the most simple Wall Fixed panel to the most complex Shower Enclosures, all product configurations have been designed following standard dimensions for bathroom products as Baths, shower trays and wetrooms.

DRENCH Product features such as glass options and colours/finishes, are available in all product configurations. However our Collections are not available for all configurations. Please follow the drawings and descriptions included below to understand how DRENCH's range of products work along this brochure.

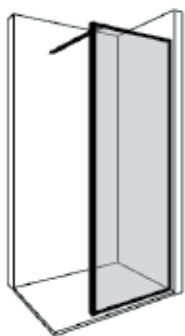

**Wall Fixed Panels**

Panel is attached to wall using our wall channels and support bar system. DRENCH Wall fixed panels are reversible so can be used both left and right hand wall fixing. Panels are available in different sizes depending on Collection. Different support bar options for panel combinations are also available.

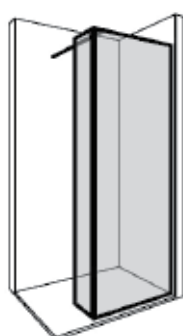

**Wall Fixed Panels with Flipper panel**

Flipper panel is fixed to the Wall fixed panel using our pivot system. The pivot mechanism swing is adjustable from 0 de to 180 degree position. Panels are handed so left or right hand wall fixing must be specified. Flipper panel is delivered already assembled to the fixed panel. It cannot be installed retrospectively.

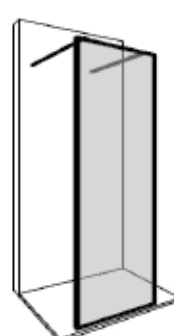

**Free Standing panels**

Freestanding Panel sits on top of wetroom/shower tray and is fixed to wall with 2 across support bars leaving a 2 entry shower area. Different panel dimensions are available and Support bars are included on the price.

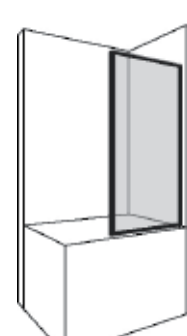

**Bath Screens**

Bath Screens are available in both Fixed and Pivot version. Fixed Bath screen are a reduced version or our Wall fixed panels suitable to be installed onto a bath. Pivot Bath Screens are hinged to the wall and swing 180 degrees. Pivot bath screens are handed.

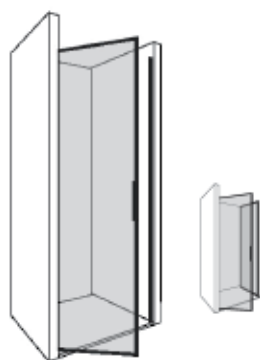

**Shower Doors & Enclosures**

DRENCH Shower doors are robust and very sophisticated. Door can be Right or Left hand hinge. The way we identify the handing is the position of the hinge when you look at it from the outside.

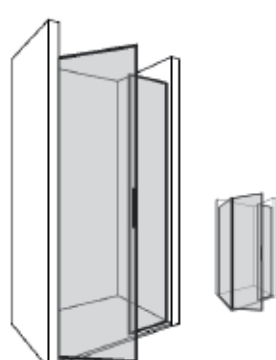

**Doors with inline & Enclosures**

Door is hinged to wall/return panel and closes into the Inline panel. Door can be Right or Left hand hinge. The way we identify the handing is the position of the hinge when you look at it from the outside.

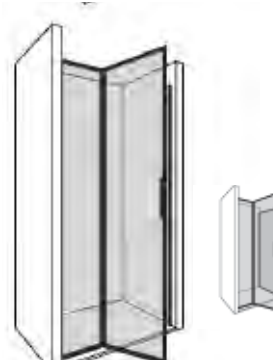

**Doors hinged to inline & Enclosures**

Door is hinged to the Inline panel closing into the wall/return panel. Door can be Right or Left hand hinge. The way we identify the handing is the position of the hinge when you look at it from the outside.









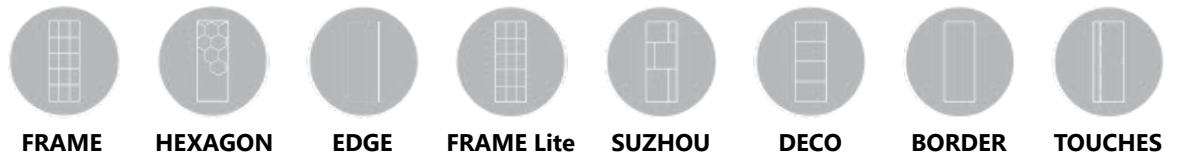

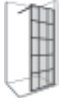
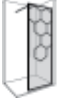





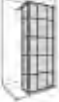
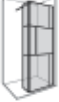



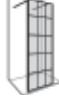
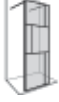
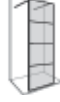











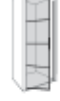



















**Shower Trays**

BASE Collection introduces our range of Slate textured Shower Trays to match and be used with our Shower Panels and enclosures. With four colour options and different grating styles, we encourage your mind to be creative.

# Product Configurations vs Collections



	FRAME	HEXAGON	EDGE	FRAME Lite	SUZHOU	DECO	BORDER	TOUCHES
 <b>Wall Fixed Panels</b>								×
 <b>Wall Fixed Panels with Flipper panel</b>	×	×	×					×
 <b>Free Standing panels</b>	×	×						×
 <b>Bath Screens</b>	×	×	×					×
 <b>Shower Doors &amp; Enclosures</b>	×	×	×	 	 	 	 	 
 <b>Doors with inline &amp; Enclosures</b>	×	×	×	 	 	 	 	 
 <b>Doors hinged to inline &amp; Enclosures</b>	×	×	×	 	 	 	 	 

# MATTE Colours

The metalwork is finished using **Architectural Powder Coating** which produces a highly durable surface ordinarily suitable for external use in any weather. For our shower enclosures this means the finish is robust enough, even for the busiest family bathroom, and the colour will always look perfect.



## **Matt Black**

(BK)

*The standard of our bold design.  
Black means power & control.  
Sophistication & Elegance.*

RAL 9005



## **Graphite Grey**

(GG)

*Industrial grey with blue shades,  
commonly known as Anthracite.  
Solid, Stable & Neutral.*

RAL 7024



## **Gun Metal**

(GM)

*Elegant dark gray with a bronze  
tinge ideal for contrasting colours  
and bold designs.*

RAL 8019



## **Blanc**

(BL)

*Offering a sense of peace and calm,  
this off white is purity, innocence  
and completion.*

RAL 9002

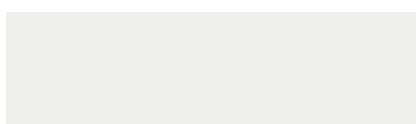

## **Total White**

(TT)

*Similar to its ability to  
reflect the light, a full white creates  
a sense of space in any room.*

RAL 9003



## **Forest**

(FO)

*Sensual, sensitive and warm.  
It highlights quality of materials.  
Comfort & Structure*

RAL 6009



**Burnt Orange**

(BO)

*It's a refreshing twist. Use this bright and bold colour as an accent to play it safe.*

RAL 3022



**Lemon Yellow**

(LY)

*Yellow is uplifting and illuminating, offering hope, happiness and fun.*

RAL 1012



**Pale Pink**

(PP)

*Pink is intuitive and insightful, showing tenderness and kindness with its empathy and sensitivity.*

RAL 3015



**Mint**

(MI)

*It relates to balance and harmony. The colour of growth, of spring, of renewal and rebirth.*

RAL 6019



**Capri Blue**

(CB)

*Mediterranean blue that creates a wonderfully tranquil space, heavenly ideal for bathrooms.*

RAL 5019



**Gey Navy**

(GN)

*It is a deep midnight blue. Sincerity, Intuition and the higher mind colour.*

RAL 5008

# Metallic Finishes

Inspired by the latest taps and brasware trends, DRENCH launched a new range of metallic finishes widening the spectrum of sheens to a new level. Since shiny and polished finishes from the eighties are still in vogue, we believe our brushed metallic range of colours adds the perfect accent to any bathroom design.

Our metallic finishes are achieved through anodising aluminium. Anodising is an electrolytic process that applies an oxide film on aluminium.

This film increases the metal's naturally good corrosion resistance, and protects any polishing, brushing, etching or brightening.



## **Brushed Brass**

(BB)

*Elegant, timeless and luxurious yellow-coloured finish.*



## **Brushed Steel**

(BS)

*Driven by industrial chic trend, an impactful yet elegant steel look.*

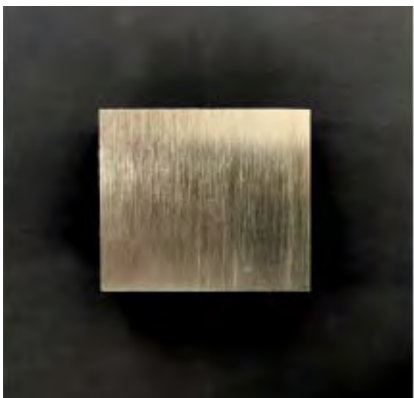

## **Light Bronze**

(LB)

*Bronze finish in between copper and brass.*

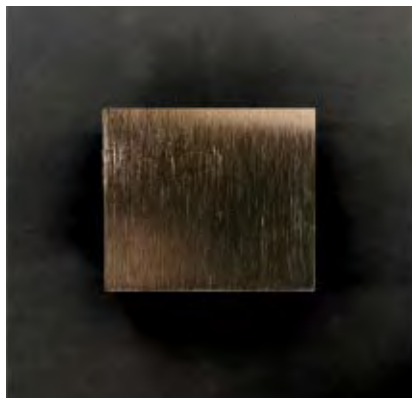

## **Dark Bronze**

(DB)

*Evoking oil rubbed bronze finish, warm and sophisticated.*

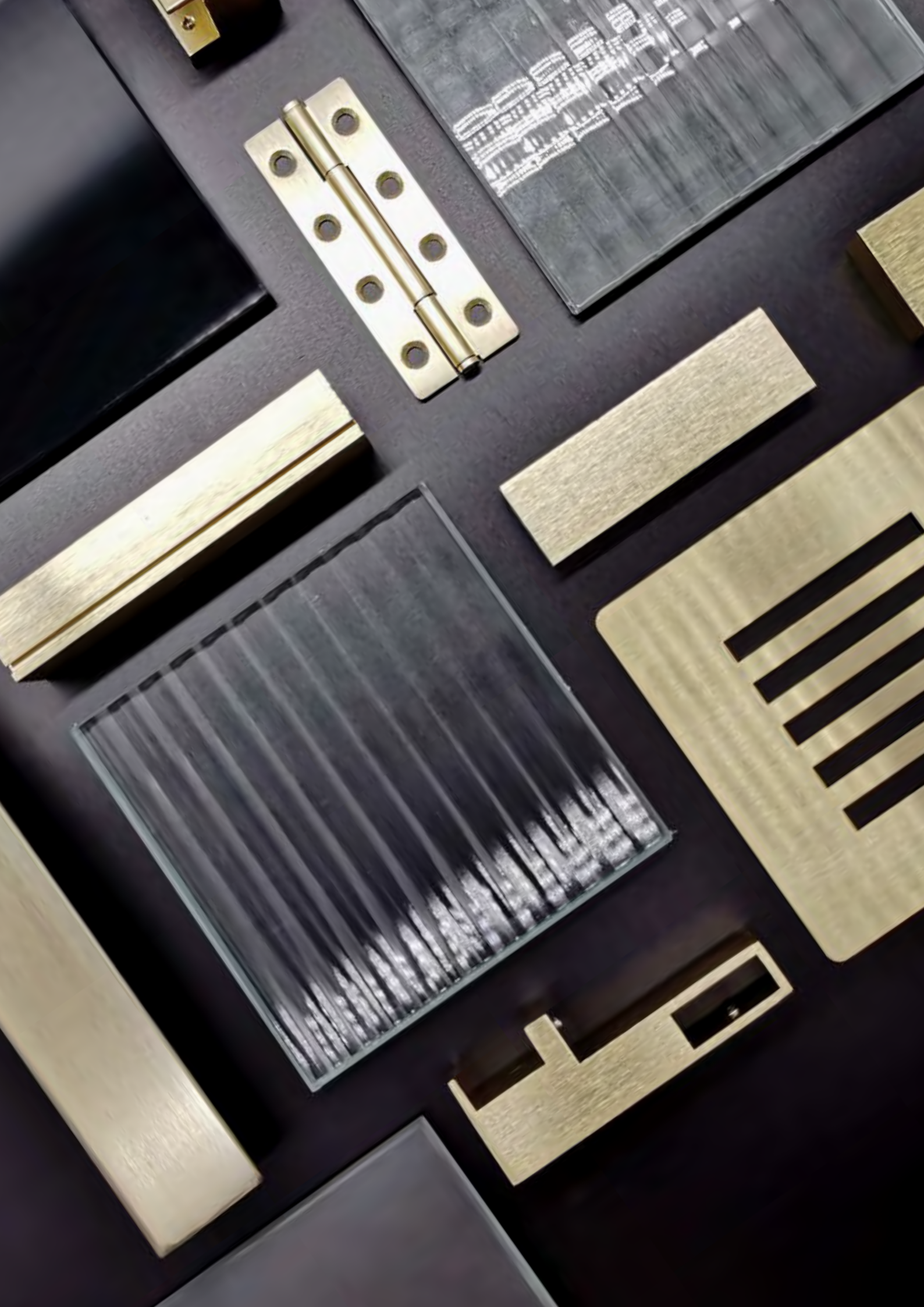

# The Collections '23



**EDGE**

Pages 16 -21



**FRAME**

Pages 22 - 27



**HEXAGON**

Pages 28 -33



**FRAME  
Lite**

Pages 34 -65



## **SUZHOU**

Pages 66 -97



## **DECO**

Pages 98 -129

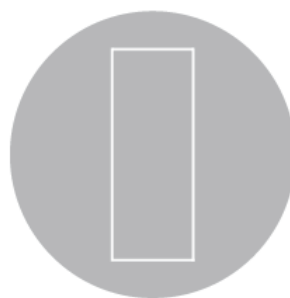

## **BORDER**

Pages 130 -161



## **TOUCHES**

Pages 162 -171



*Wall Fixed Panel 1200 x 1981 & 900 x 1981 mm. Matt Black, Fluted Glass + FLSTBAR*



**EDGE**  
Collection





## EDGE Collection

### FEATURES:

12 Different sizes available

1981 mm Height

15 mm of Adjustment

12 MATTE Colours & 4 Metallic Finishes

8 mm Toughened - Safety Glass

Fluted and Clear Glass options

Easy Clean Coating

\* Selection of support bars for panel combinations.

### Semi Frameless Panels

A Semi frameless panel features a mix of framed glass and frameless glass.

DRENCH Showers, experts on different finishes and colours as well as glass options; designed the EDGE collection for those that are looking for simplistic and sleek look. Wall channel and support bar add the accent of colour to the panel and the glass can be ordered in both Clear and Fluted.



8 mm Toughened  
Clear Glass



8 mm Toughened  
Fluted Glass

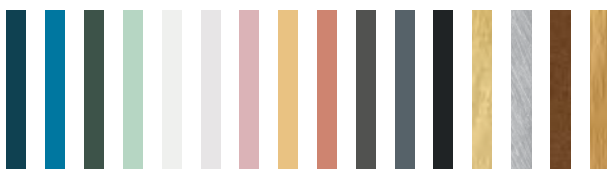

**Product Configurations Available**



**Support bars for Panel Combinations**

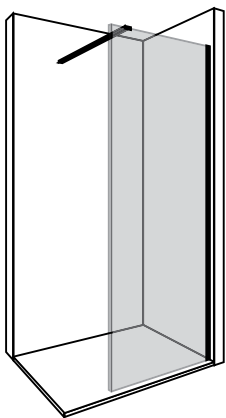

**FLSCRS**

**Across Support Bar**

Support Bar is installed across the wall. It is supplied at 1000 mm length. Support bar includes wall connector, panel connector & bar.

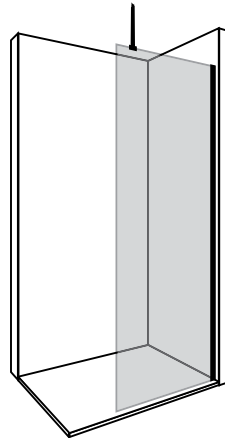

**FLSCLN**

**Ceiling Support Bar**

Support Bar is installed from the top of the screen up to the ceiling. It is supplied at 450 mm length. Support bar includes ceiling connector, panel connector & bar.

**For panels wider than 1000 mm, 2 support bars may be required.**

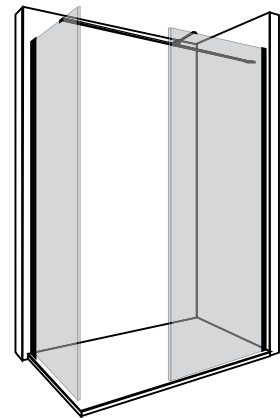

**FLSTBAR**

**T Shape Support Bar**

Support Bar is installed parallel to the longer side of the walk in shower. Support bar includes wall connector, t-shape connector panel connector & 2 x bars.



# EDGE Collection

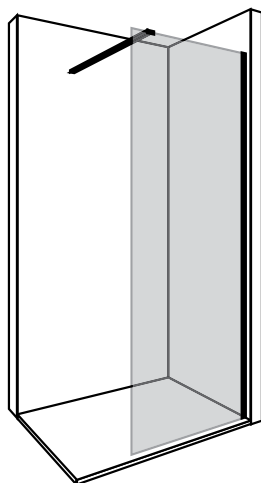

## Semiframeless Shower Panels

At DRENCH we also like simplistic and sleek designs, therefore, the EDGE collection is now available. Our Semi frameless range of Shower panels are equipped with a greater strength piece of glass, both Clear and Fluted are available. Wall channel and support bar finished in the desired colour option, both MATTE colours and Metallic finishes are available.

### Steps for ordering;

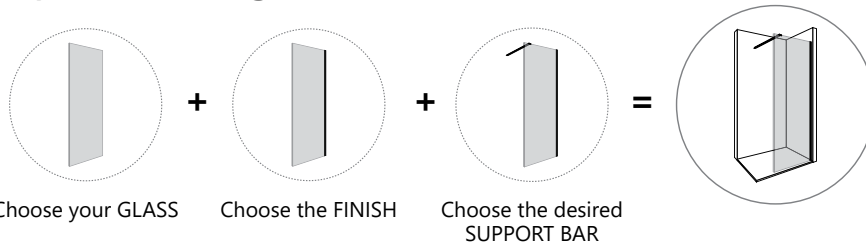

### GLASS Options available

Please choose your GLASS size. Please add **CLR** for Clear Glass or **FLT** for Fluted when ordering.



Item Code	Item Description	Height (mm)	Adjustment (Min - Max)	Retail Price (Exc VAT) CLEAR GLASS CLR	Retail Price (Exc VAT) FLUTED GLASS FLT
GLS30...	Toughened Glass for Semi Frameless Panel <b>280 mm width</b>	1981	273 - 288	<b>£105</b>	-
GLS40...	Toughened Glass for Semi Frameless Panel <b>380 mm width</b>	1981	373 - 388	<b>£127</b>	-
GLS50...	Toughened Glass for Semi Frameless Panel <b>480 mm width</b>	1981	473 - 488	<b>£148</b>	<b>£376</b>
GLS60...	Toughened Glass for Semi Frameless Panel <b>580 mm width</b>	1981	573 - 588	<b>£170</b>	<b>£445</b>
GLS70...	Toughened Glass for Semi Frameless Panel <b>680 mm width</b>	1981	673 - 688	<b>£192</b>	<b>£514</b>
GLS76...	Toughened Glass for Semi Frameless Panel <b>740 mm width</b>	1981	733 - 748	<b>£201</b>	<b>£551</b>
GLS80...	Toughened Glass for Semi Frameless Panel <b>780 mm width</b>	1981	773 - 788	<b>£214</b>	<b>£583</b>
GLS90...	Toughened Glass for Semi Frameless Panel <b>880 mm width</b>	1981	873 - 888	<b>£236</b>	<b>£652</b>
GLS100...	Toughened Glass for Semi Frameless Panel <b>980 mm width</b>	1981	973 - 988	<b>£258</b>	<b>£721</b>
GLS110...	Toughened Glass for Semi Frameless Panel <b>1080 mm width</b>	1981	1073 - 1088	<b>£280</b>	<b>£790</b>
GLS120...	Toughened Glass for Semi Frameless Panel <b>1180 mm width</b>	1981	1173 - 1188	<b>£301</b>	<b>£859</b>
GLS140...	Toughened Glass for Semi Frameless Panel <b>1380 mm width</b>	1981	1373 - 1388	<b>£338</b>	<b>£990</b>

### WALL PROFILE Options available

Please add the two letter colour code to your PR8 code.

Item Code	Item Description	Retail Price MATTE Colours (Exc VAT)	Retail Price Metallic Finishes (Exc VAT)
PR8..	Wall Channel for Semiframeless Shower Panel	<b>£134</b>	<b>£208</b>





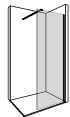
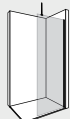
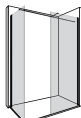





## SUPPORT BAR Options available

Please choose the desired support bar and add the two letter colour code to your item code.

Item Code	Item Description		Retail Price <b>MATTE Colours</b> (Exc VAT)	Retail Price <b>Metallic Finishes</b> (Exc VAT)
FLSCRS..	<b>Across Support Bar</b> <i>(3 components, not pre-assembled)</i> 1000 mm length, 30 x 10 mm bar.		<b>£99</b>	<b>£135</b>
FLSCLN..	<b>Ceiling Support Bar</b> <i>(3 components, not pre-assembled)</i> 450 mm length, 30 x 10 mm bar.		<b>£99</b>	<b>£109</b>
FLSTBAR..	<b>T Shape Support bar</b> <i>(4 components, not pre-assembled)</i> 2x 30 x 10 mm bars. Long bar 1200 mm + Short bar at 1000 mm <b>**Suitable for Shower Panels combinations**</b>		<b>£139</b>	<b>£235</b>

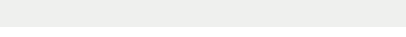



Please check SAMPLE LAYOUTS below for further details and inspiration.

### MATTE Colours available

	BK	<b>Matt Black</b>	RAL 9005
	GG	<b>Graphite Grey</b>	RAL 7024
	GM	<b>Gun Metal</b>	RAL 8019
	BO	<b>Burnt Orange</b>	RAL 3022
	LY	<b>Lemon Yellow</b>	RAL 1012
	PP	<b>Pale Pink</b>	RAL 3015
	BL	<b>Blanc</b>	RAL 9002
	TT	<b>Total White</b>	RAL 9003
	MI	<b>Mint</b>	RAL 6019
	FO	<b>Forest</b>	RAL 6009
	CB	<b>Capri Blue</b>	RAL 5019
	GN	<b>Grey Navy</b>	RAL 5008

Any RAL Classic colours are available  
plus 35% to prices above.

### Metallic Finishes available

	<b>Light Bronze</b>	Anodised	LB
	<b>Dark Bronze</b>	Anodised	DB
	<b>Brushed Steel</b>	Anodised	BS
	<b>Brushed Brass</b>	Anodised	BB

### Sample Layouts

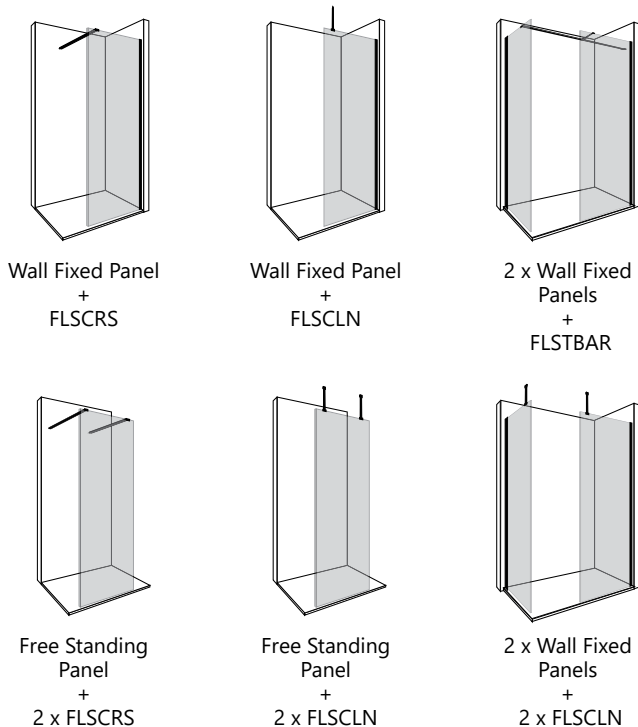



*Wall Fixed Panel 1200 x 2100 mm. Matt Black, Clear Glass*



# FRAME

Collection





# FRAME Collection

## FEATURES:

8 Different sizes available

2100 mm Height

19 mm of Adjustment

Mat Black metalwork.

8 mm Toughened Glass

(Fluted, Frosted & Grey Tinted Glass options)

Easy Clean Coating

Selection of support bars for panel combinations.

The FRAME Collection creates an impact with its horizontal and vertical grid metalwork, specially designed to reach the industrial chic trend look; eclectic but elegant.

The design brings intimacy to your shower, filling the space with character, and it brings great inspiration to design your bathroom.

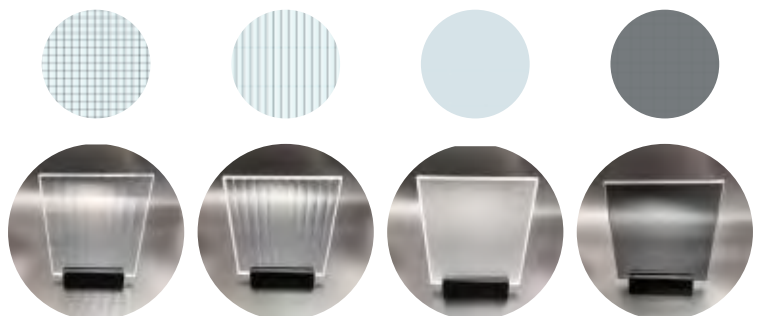
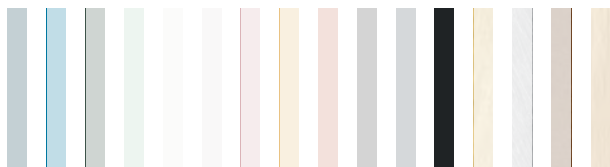

**Cross Fluted**

8.8 mm TGH  
Laminated

**Fluted**

8.8 mm TGH  
Laminated

**Frosted**

8 mm TGH  
Satin Etch

**Grey Tinted**

8 mm TGH  
Smoked glass

**Product Configurations Available**



**Support bars for Panel Combinations**

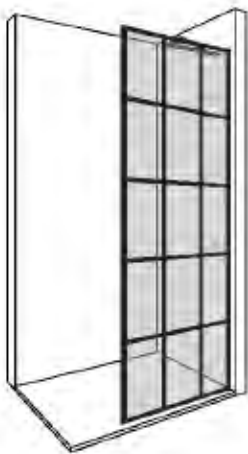

**FXFRANGL**  
Angle Support Bar

Angle Support Bar is installed in parallel to the panel and just behind the top profile.

It is 450 mm long and can only be used for **units no wider than 1000 mm (included)**.

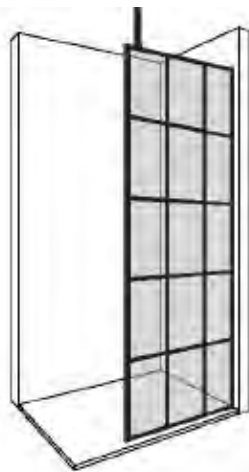

**FXFRACLN**  
Ceiling Support Bar

Support Bar is installed from the top of the screen to the ceiling. It is supplied at 450 mm length.

Support bar includes ceiling connector, panel connector & bar. **For panels wider than 1000 mm, 2 support bars may be required.**

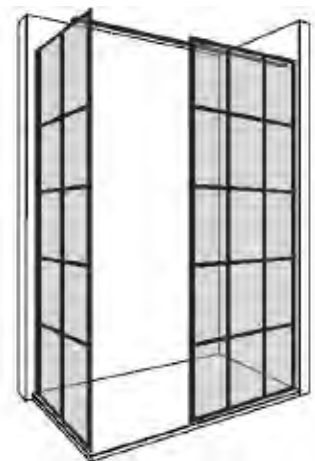

**FXFRADBL**  
T Shape Support Bar

Support Bar is installed parallel to the longer side of the walk in shower. Support bar includes wall connector, t-shape connector panel connector & bar.

**Maximum length of this bar is 2000 mm.**



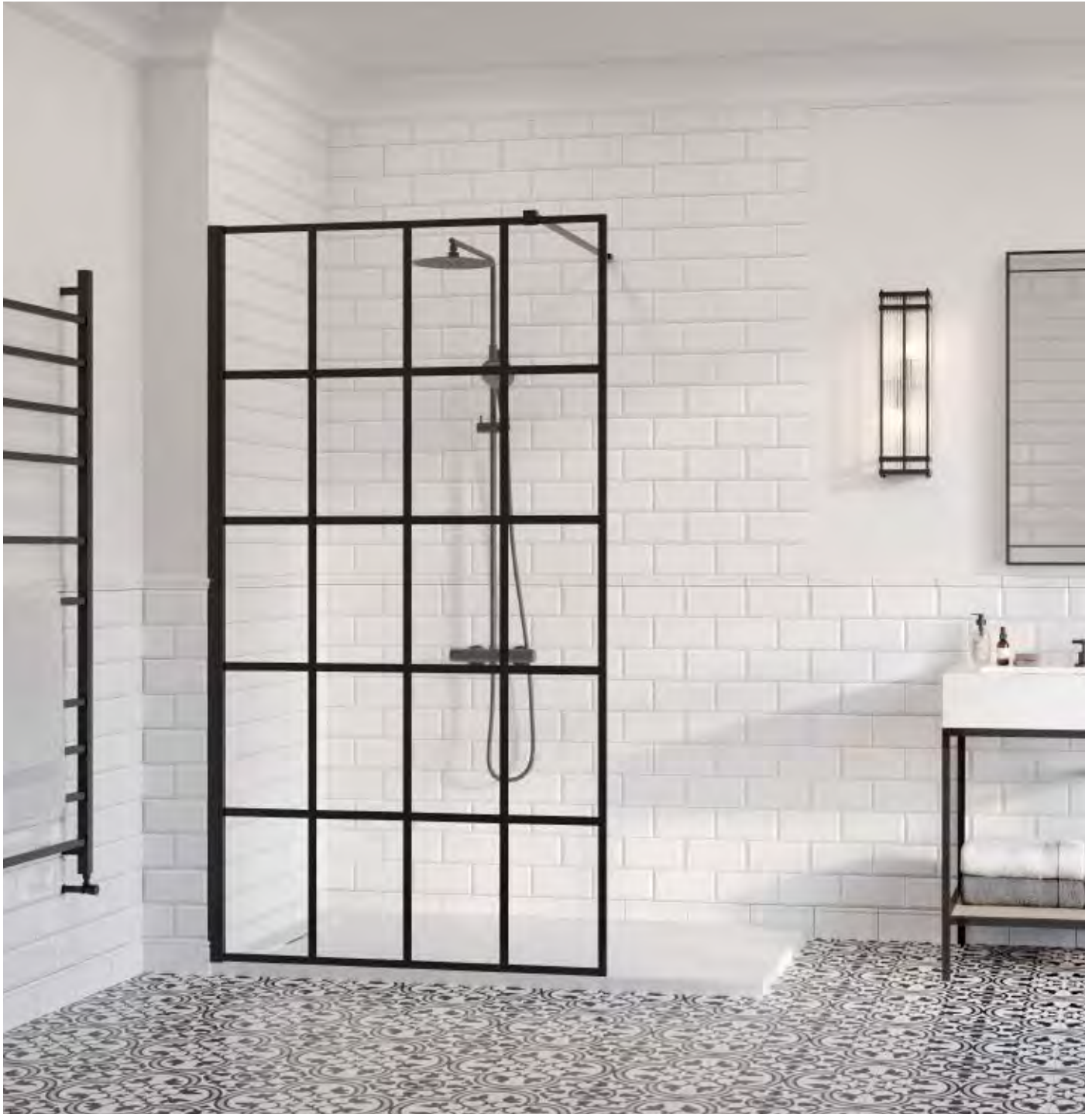

## Wall Fixed Panels



Panel is attached to the Wall using Wall Channel and Support Bar.





# FRAME Collection

## Wall Fixed Panels

Please choose your codes depending on width required.

Prices below are RRP exc VAT for CLEAR GLASS, other GLASS OPTIONS are available plus additional surcharge.

Item Code	Description	Adjustment Range	Retail Price Exc VAT (Clear Glass)
<b>FXFRA50</b>	Fixed Panel <b>500 mm x 2100 mm</b> **FXFRANGL - Angle Support Bar**	460 - 480 mm	<b>£1,047</b>
<b>FXFRA60</b>	Fixed Panel <b>600 mm x 2100 mm</b> **FXFRANGL - Angle Support Bar**	560 - 580 mm	<b>£1,175</b>
<b>FXFRA70</b>	Fixed Panel <b>700 mm x 2100 mm</b> **FXFRANGL - Angle Support Bar**	660 - 680 mm	<b>£1,302</b>
<b>FXFRA80</b>	Fixed Panel <b>800 mm x 2100 mm</b> **FXFRACRS - Accross Support Bar**	760 - 780 mm	<b>£1,430</b>
<b>FXFRA90</b>	Fixed Panel <b>900 mm x 2100 mm</b> **FXFRACRS - Accross Support Bar**	860 - 880 mm	<b>£1,560</b>
<b>FXFRA100</b>	Fixed Panel <b>1000 mm x 2100 mm</b> **FXFRACRS - Accross Support Bar**	960 - 980 mm	<b>£1,715</b>
<b>FXFRA120</b>	Fixed Panel <b>1200 mm x 2100 mm</b> **FXFRACRS - Accross Support Bar**	1160 - 1180 mm	<b>£1,963</b>
<b>FXFRA140</b>	Fixed Panel <b>1400 mm x 2100 mm</b> **FXFRACRS - Accross Support Bar**	1360 - 1380 mm	<b>£2,210</b>

Please NOTE Support bars are included on price as per Product descriptions.

### Colours available

BK **Matt Black** RAL 9005

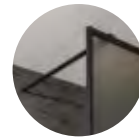

**FXFRACRS**  
Across Support Bar  
1000 mm



**FXFRANGL**  
Angle Support Bar  
450 mm

### Metalwork Design layout

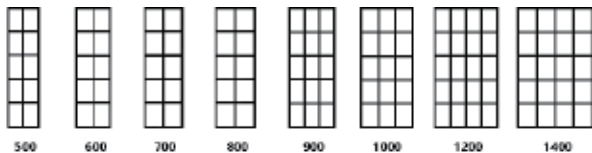

### Glass Options available

Please NOTE other Glass options are available plus additional surcharge to prices listed above.

Plus 45% additional

Plus 35% additional

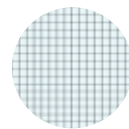

**Cross Fluted**  
8.8 mm TGH  
Laminated



**Fluted**  
8.8 mm TGH  
Laminated



**Frosted**  
8 mm TGH  
Satin Etch

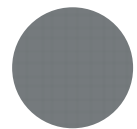

**Grey Tinted**  
8 mm TGH  
Smoked glass

## Fixed Panels Combinations



For Walk In showers with FRAME Fixed panels, **Return Panel support bar (FXFRADBL)** is highly recommended for installation purposes.

Please specify the length required and specify code & price on your order.



**FXFRADBL**  
Return panel Support Bar  
\*\*Length to be specified\*\*

+ **£193 Exc VAT**



*Wall Fixed Panel 1200 x 2100 mm. Graphite Grey Clear Glass*



# HEXAGON

Collection





# HEXAGON Collection

## FEATURES:

8 Different sizes available

2100 mm Height

19 mm of Adjustment

12 MATTE Colours.

8 mm Toughened Glass

(Fluted, Frosted & Grey Tinted Glass options)

Easy Clean Coating

\*Selection of support bars for panel combinations.

The hexagonal shape is just the start of it. The design engages your eye and inspires through the six-sided symmetric shape. Hexagonal tiles are quite a thing and very rarely, especially on the bigger sized ones, are used creating a whole pattern but mix of different colours and textures.

HEXAGON collection is only available for DRENCH Fixed panels range; the ideal addition to your Walk-In shower space.

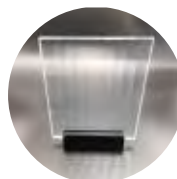
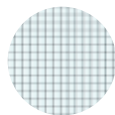

**Cross Fluted**

8.8 mm TGH  
Laminated

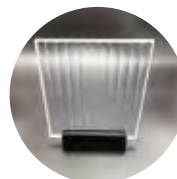

**Fluted**

8.8 mm TGH  
Laminated

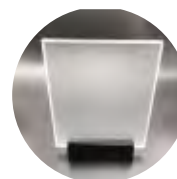

**Frosted**

8 mm TGH  
Satin Etch

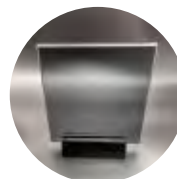

**Grey Tinted**

8 mm TGH  
Smoked glass



Product Configurations Available



Support bars for **Panel Combinations**

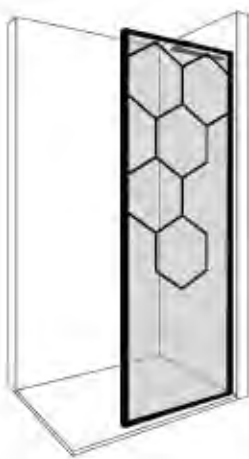

**FXSBNGL**  
Angle Support Bar

Angle Support Bar is installed in parallel to the panel and just behind the top profile.

It is 450 mm long and can only be used for **units no wider than 1000 mm. (included)**

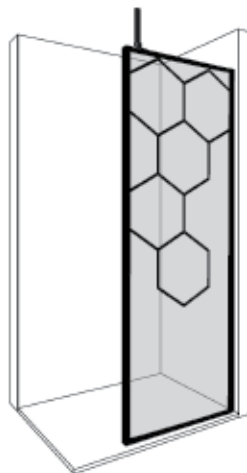

**FXSBCLN**  
Ceiling Support Bar

Support Bar is installed from the top of the screen up to the ceiling. It is supplied at 450 mm length.

Support bar includes ceiling connector, panel connector & bar. **For panels wider than 1000 mm, 2 support bars may be required.**

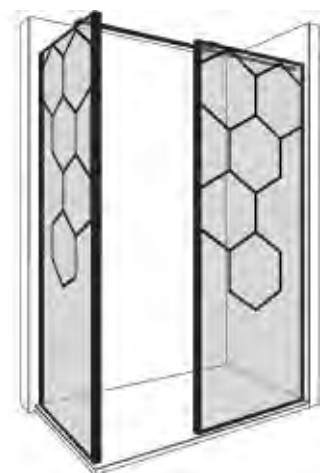

**FXSBDBL**  
T Shape Support Bar

Support Bar is installed parallel to the longer side of the walk in shower. Support bar includes wall connector, t-shape connector panel connector & bar.

**Maximum length of this bar is 2000 mm.**





## Wall Fixed Panels



Panel is attached to the Wall using Wall Channel and Support Bar.



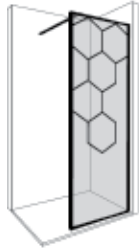

# HEXAGON Collection

## Wall Fixed Panels

Please choose your codes depending on width required and add the two letter colour code to it. Prices below are RRP exc VAT for CLEAR GLASS, other GLASS OPTIONS are available plus additional surcharge.

Item Code	Description	Adjustment Range	Retail Price Exc VAT (Clear Glass)
FXHEX70L.. FXHEX70R..	Fixed Panel <b>700 mm x 2100 mm</b> **FXSBNGL - Angle Support Bar**	675 - 690 mm	<b>£1,657</b>
FXHEX80L.. FXHEX80R..	Fixed Panel <b>800 mm x 2100 mm</b> **FXSBCRS - Across Support Bar**	775 - 790 mm	<b>£1,774</b>
FXHEX90L.. FXHEX90R..	Fixed Panel <b>900 mm x 2100 mm</b> **FXSBCRS - Across Support Bar**	875 - 890 mm	<b>£1,888</b>
FXHEX100L.. FXHEX100R..	Fixed Panel <b>1000 mm x 2100 mm</b> **FXSBCRS - Across Support Bar**	975 - 990 mm	<b>£2,029</b>
FXHEX120L.. FXHEX120R..	Fixed Panel <b>1200 mm x 2100 mm</b> **FXSBCRS - Across Support Bar**	1175 - 1190 mm	<b>£2,252</b>

Please NOTE Support bars are included on price as per Product descriptions.

### MATTE Colours available

	BK	<b>Matt Black</b>	RAL 9005
	GG	<b>Graphite Grey</b>	RAL 7024
	GM	<b>Gun Metal</b>	RAL 8019
	BO	<b>Burnt Orange</b>	RAL 3022
	LY	<b>Lemon Yellow</b>	RAL 1012
	PP	<b>Pale Pink</b>	RAL 3015
	BL	<b>Blanc</b>	RAL 9002
	TT	<b>Total White</b>	RAL 9003
	MI	<b>Mint</b>	RAL 6019
	FO	<b>Forest</b>	RAL 6009
	CB	<b>Capri Blue</b>	RAL 5019
	GN	<b>Grey Navy</b>	RAL 5008

Any RAL Classic colours are available **plus 35% to prices above**. For both RAL and Glass Option together please add 65% to prices above.

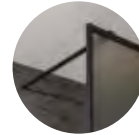

**FXSBCRS**  
Across Support Bar  
1000 mm



**FXSBNGL**  
Angle Support Bar  
450 mm

### Metalwork Design layout

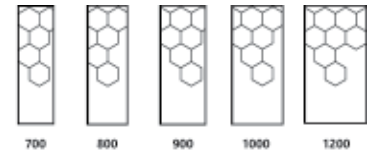

### Glass Options available

Please NOTE other Glass options are available plus additional surcharge to prices listed above.

Plus 45% additional

Plus 35% additional

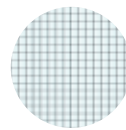

**Cross Fluted**  
8.8 mm TGH  
Laminated



**Fluted**  
8.8 mm TGH  
Laminated



**Frosted**  
8 mm TGH  
Satin Etch

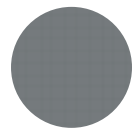

**Grey Tinted**  
8 mm TGH  
Smoked glass

## Fixed Panels Combinations



For Walk-In showers with HEXAGON Fixed panels, **Return Panel support bar (FXSBDBL)** is highly recommended for installation purposes.

Please specify the length required and specify code & price on your order.



**FXSBDBL**  
Return panel Support Bar  
\*\*Length to be specified\*\*

**+ £193 Exc VAT**



*Shower Door hinged to Inline 1200 closing into Return Panel 900 mm.  
Brushed Brass, Fluted Glass.*



# FRAME Lite Collection





# FRAME Lite Collection

## FEATURES:

*ALL Product configurations*

*2100 mm Height*

*19 mm of Adjustment*

*12 MATTE Colours & 4 Metallic Finishes*

*8 mm Toughened Glass*

*(Fluted, Frosted, Grey Tinted & Clear Glass options)*

*Easy Clean Coating*

Driven by the success of Frame, FRAME Lite was launched based on our popular grid metalwork pattern.

FRAME Lite provides the balance between the industrial style and the simplification of the grid especially in small spaces, using 15 mm aluminum bars width.

FRAME Lite collection is available for all DRENCH ranges including Panels, Bath Screens, Shower Doors & Shower Enclosures.

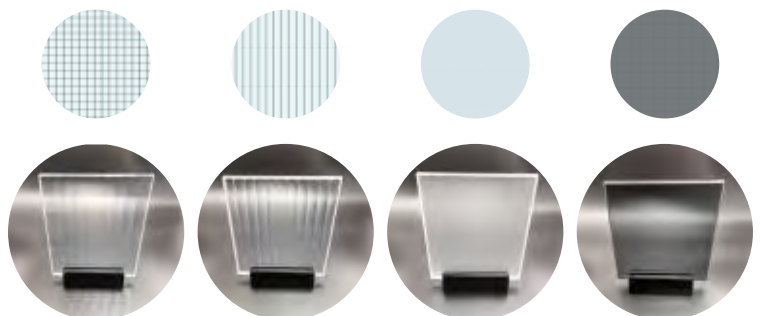
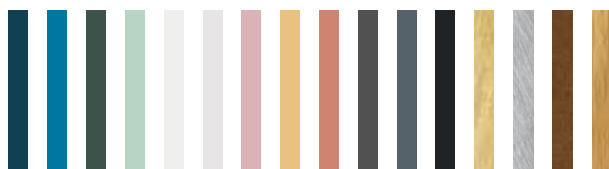

**Cross Fluted**

8.8 mm TGH Laminated

**Fluted**

8.8 mm TGH Laminated

**Frosted**

8 mm TGH Satin Etch









**Grey Tinted**

8 mm TGH Smoked glass

**Product Configurations Available**



**Standard Dimensions Vs Product Configuration**

	300	400	500	600	700	800	900	1000	1200	1400	1500	1600
 <b>Wall Fixed Panels</b> Standard Height 2100 mm											✗	✗
 <b>Wall Fixed Panels with Flipper Panel</b> Standard Height 2100 mm											✗	✗
 <b>Free Standing Panels</b> Standard Height 2100 mm	✗	✗	✗	✗	✗						✗	✗
 <b>Single Shower Doors</b> Standard Height 2100 mm	✗	✗	✗	✗				✗	✗	✗	✗	✗
 <b>Shower Doors with Inline Panel</b> Standard Height 2100 mm	✗	✗	✗	✗	✗	✗						
 <b>Shower Doors hinged to Inline Panel</b> Standard Height 2100 mm	✗	✗	✗	✗	✗	✗						
 <b>Return Panels for Shower Enclosures</b> Standard Height 2100 mm	✗	✗	✗	✗					✗	✗	✗	✗
 <b>Bath Screens (Pivot &amp; Fixed)</b> Standard Height 1500 mm	✗	✗	✗	✗	✗		✗	✗	✗	✗	✗	✗



## Wall Fixed Panels

Panel is attached to the Wall using Wall Channel and Support Bar.

# MATTE Colours





# FRAME Lite MATTE Colours

## Wall Fixed Panels

Please choose your codes depending on width required and add the two letter colour code to it. Prices below are RRP exc VAT for CLEAR GLASS, other GLASS OPTIONS are available plus additional surcharge.

Item Code	Description	Adjustment Range	Retail Price Exc VAT (Clear Glass)
FXLTE30..	Fixed Panel <b>300 mm x 2100 mm</b> <i>**No support Bar Included**</i>	275 - 290 mm	£697
FXLTE40..	Fixed Panel <b>400 mm x 2100 mm</b> <i>**No support Bar Included**</i>	375 - 390 mm	£752
FXLTE50..	Fixed Panel <b>500 mm x 2100 mm</b> <i>**FXSBNGL - Angle Support Bar**</i>	475 - 490 mm	£809
FXLTE60..	Fixed Panel <b>600 mm x 2100 mm</b> <i>**FXSBNGL - Angle Support Bar**</i>	575 - 590 mm	£86
FXLTE70..	Fixed Panel <b>700 mm x 2100 mm</b> <i>**FXSBNGL - Angle Support Bar**</i>	675 - 690 mm	£924
FXLTE80..	Fixed Panel <b>800 mm x 2100 mm</b> <i>**FXSBCRS - Accross Support Bar**</i>	775 - 790 mm	£1,363
FXLTE90..	Fixed Panel <b>900 mm x 2100 mm</b> <i>**FXSBCRS - Accross Support Bar**</i>	875 - 890 mm	£1,316
FXLTE100..	Fixed Panel <b>1000 mm x 2100 mm</b> <i>**FXSBCRS - Accross Support Bar**</i>	975 - 990 mm	£1,374
FXLTE120..	Fixed Panel <b>1200 mm x 2100 mm</b> <i>**FXSBCRS - Accross Support Bar**</i>	1175 - 1190 mm	£1,532
FXLTE140..	Fixed Panel <b>1400 mm x 2100 mm</b> <i>**FXSBCRS - Accross Support Bar**</i>	1375 - 1390 mm	£1,652

Please NOTE Support bars are included on price as per Product descriptions. For dimensions that do not fit our Standard range please contact us, we are experts on Bespoke and made to measure projects. Please email us at [sales@drenchshowers.co.uk](mailto:sales@drenchshowers.co.uk).

### MATTE Colours available

BK	<b>Matt Black</b>	RAL 9005
GG	<b>Graphite Grey</b>	RAL 7024
GM	<b>Gun Metal</b>	RAL 8019
BO	<b>Burnt Orange</b>	RAL 3022
LY	<b>Lemon Yellow</b>	RAL 1012
PP	<b>Pale Pink</b>	RAL 3015
BL	<b>Blanc</b>	RAL 9002
TT	<b>Total White</b>	RAL 9003
MI	<b>Mint</b>	RAL 6019
FO	<b>Forest</b>	RAL 6009
CB	<b>Capri Blue</b>	RAL 5019
GN	<b>Grey Navy</b>	RAL 5008

Any RAL Classic colours are available **plus 35% to prices above**. For both RAL and Glass Option together please add **65% to prices above**.

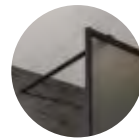

**FXSBCRS**  
Across Support Bar  
1000 mm



**FXSBNGL**  
Angle Support Bar  
450 mm

### Metalwork Design layout

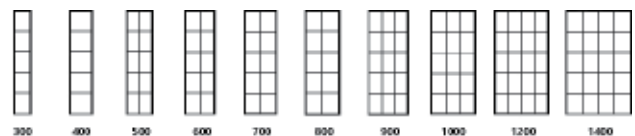

### Glass Options available

Please NOTE other Glass options are available plus additional surcharge to prices listed above.

Plus 45% additional

Plus 35% additional

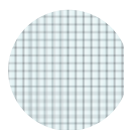

**Cross Fluted**  
8.8 mm TGH  
Laminated



**Fluted**  
8.8 mm TGH  
Laminated



**Frosted**  
8 mm TGH  
Satin Etch

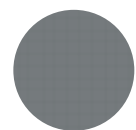

**Grey Tinted**  
8 mm TGH  
Smoked glass



## Fixed Panels with Flipper Panel

**Flipper panel is delivered already assembled to the fixed panel.**

It cannot be installed retrospectively. The pivot mechanism is adjustable from 0 de to 180 degree position.

# MATTE Colours





# FRAME Lite MATTE Colours

## Fixed Panels with Flipper

Please choose your codes depending on width required and add the two letter colour code to it.  
**NOTE This item is Handed so Left or Right Hand need to be specified.**



**LH**  
Left Hand



**RH**  
Right Hand

Item Code	Description	Adjustment Range	Retail Price Exc VAT (Clear Glass)
FXLTE30FLIPL.. FXLTE30FLIPR..	Fixed Panel <b>300 x 2100 mm with 300 Flipper.</b> R: Right Hand wall fixing / L: Left Hand wall fixing **FXSBNGL - Angle Support Bar**	580 - 590 mm	£1,114
FXLTE40FLIPL.. FXLTE40FLIPR..	Fixed Panel <b>400 x 2100 mm with 300 Flipper.</b> R: Right Hand wall fixing / L: Left Hand wall fixing **FXSBNGL - Angle Support Bar**	680 - 690 mm	£1,168
FXLTE50FLIPL.. FXLTE50FLIPR..	Fixed Panel <b>500 x 2100 mm with 300 Flipper.</b> R: Right Hand wall fixing / L: Left Hand wall fixing **FXSBCRS - Across Support Bar**	780 - 790 mm	£1,226
FXLTE60FLIPL.. FXLTE60FLIPR..	Fixed Panel <b>600 x 2100 mm with 300 Flipper.</b> R: Right Hand wall fixing / L: Left Hand wall fixing **FXSBCRS - Across Support Bar**	880 - 890 mm	£1,283
FXLTE70FLIPL.. FXLTE70FLIPR..	Fixed Panel <b>700 x 2100 mm with 300 Flipper.</b> R: Right Hand wall fixing / L: Left Hand wall fixing **FXSBCRS - Across Support Bar**	980 - 990 mm	£1,340
FXLTE80FLIPL.. FXLTE80FLIPR..	Fixed Panel <b>800 x 2100 mm with 300 Flipper.</b> R: Right Hand wall fixing / L: Left Hand wall fixing **FXSBCRS - Across Support Bar**	1080 - 1090 mm	£1,678
FXLTE90FLIPL.. FXLTE90FLIPR..	Fixed Panel <b>900 x 2100 mm with 300 Flipper.</b> R: Right Hand wall fixing / L: Left Hand wall fixing **FXSBCRS - Across Support Bar**	1180 - 1190 mm	£1,735
FXLTE100FLIPL.. FXLTE100FLIPR..	Fixed Panel <b>1000 x 2100 mm with 300 Flipper.</b> R: Right Hand wall fixing / L: Left Hand wall fixing **FXSBCRS - Across Support Bar**	1280 - 1290 mm	£1,768
FXLTE120FLIPL.. FXLTE120FLIPR..	Fixed Panel <b>1200 x 2100 mm with 300 Flipper.</b> R: Right Hand wall fixing / L: Left Hand wall fixing **FXSBCRS - Across Support Bar**	1480 - 1490 mm	£1,878
FXLTE140FLIPL.. FXLTE140FLIPR..	Fixed Panel <b>1400 x 2100 mm with 300 Flipper.</b> R: Right Hand wall fixing / L: Left Hand wall fixing **FXSBCRS - Across Support Bar**	1680 - 1690 mm	£1,971

Please NOTE Support bars are included on price as per Product descriptions.  
 For dimensions that do not fit our Standard range please email us at [sales@drenchshowers.co.uk](mailto:sales@drenchshowers.co.uk).

### MATTE Colours available

	BK	<b>Matt Black</b>	RAL 9005
	GG	<b>Graphite Grey</b>	RAL 7024
	GM	<b>Gun Metal</b>	RAL 8019
	BO	<b>Burnt Orange</b>	RAL 3022
	LY	<b>Lemon Yellow</b>	RAL 1012
	PP	<b>Pale Pink</b>	RAL 3015
	BL	<b>Blanc</b>	RAL 9002
	TT	<b>Total White</b>	RAL 9003
	MI	<b>Mint</b>	RAL 6019
	FO	<b>Forest</b>	RAL 6009
	CB	<b>Capri Blue</b>	RAL 5019
	GN	<b>Grey Navy</b>	RAL 5008

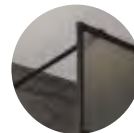

**FXSBCRS**  
Across Support Bar  
1000 mm



**FXSBNGL**  
Angle Support Bar  
450 mm

### Metalwork Design layout

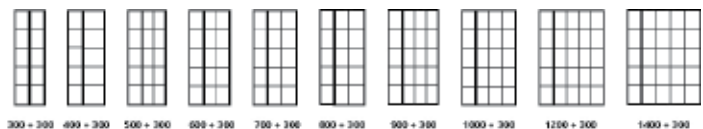

### Glass Options available

Please NOTE other Glass options are available plus additional surcharge to prices listed above.

Plus 45% additional      Plus 35% additional

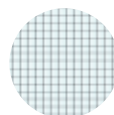

**Cross Fluted**  
8.8 mm TGH  
Laminated



**Fluted**  
8.8 mm TGH  
Laminated



**Frosted**  
8 mm TGH  
Satin Etch



**Grey Tinted**  
8 mm TGH  
Smoked glass

Any RAL Classic colours are available plus 35% to prices above. For both RAL and Glass Option together please add 65% to prices above.

# FRAME Lite MATTE Colours

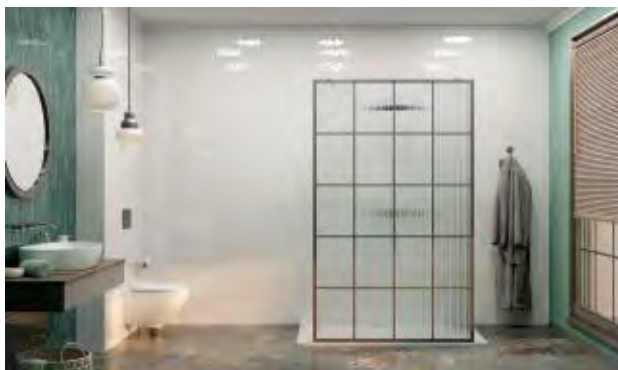

## Free Standing Panels

**Free standing Shower Screen** for Wet rooms and walk-in showers.  
2 Across Support bars included in price.

Please add the two letter colour code to your code chosen above.

Item Code	Description	Physical width of Unit	Retail Price Exc VAT (Clear Glass)
FXLTE80FST..	Free Standing Panel <b>800 mm x 2100 mm</b> **2 x FXSBCRS - Across Support Bar**	762 mm	£1,363
FXLTE90FST..	Free Standing Panel <b>900 mm x 2100 mm</b> **2 x FXSBCRS - Across Support Bar**	862 mm	£1,316
FXLTE100FST..	Free Standing Panel <b>1000 mm x 2100 mm</b> **2 x FXSBCRS - Across Support Bar**	962 mm	£1,374
FXLTE120FST..	Free Standing Panel <b>1200 mm x 2100 mm</b> **2 x FXSBCRS - Across Support Bar**	1162 mm	£1,532
FXLTE140FST..	Free Standing Panel <b>1400 mm x 2100 mm</b> **2 x FXSBCRS - Across Support Bar**	1362 mm	£1,652

Please NOTE Support bars are included on price as per Product descriptions.  
For dimensions that do not fit our Standard range please contact us, we are experts on Bespoke and made to measure projects.  
Please email us at [sales@drenchshowers.co.uk](mailto:sales@drenchshowers.co.uk).

### MATTE Colours available

	BK	<b>Matt Black</b>	RAL 9005
	GG	<b>Graphite Grey</b>	RAL 7024
	GM	<b>Gun Metal</b>	RAL 8019
	BO	<b>Burnt Orange</b>	RAL 3022
	LY	<b>Lemon Yellow</b>	RAL 1012
	PP	<b>Pale Pink</b>	RAL 3015
	BL	<b>Blanc</b>	RAL 9002
	TT	<b>Total White</b>	RAL 9003
	MI	<b>Mint</b>	RAL 6019
	FO	<b>Forest</b>	RAL 6009
	CB	<b>Capri Blue</b>	RAL 5019
	GN	<b>Grey Navy</b>	RAL 5008

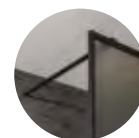

**FXSBCRS (x2)**  
Across Support Bar  
1000 mm

### Metalwork Design layout

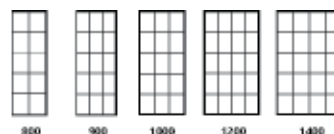

### Glass Options available

Please NOTE other Glass options are available plus additional surcharge to prices listed above.

Plus 45% additional

Plus 35% additional

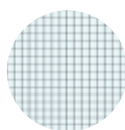

**Cross Fluted**  
8.8 mm TGH  
Laminated



**Fluted**  
8.8 mm TGH  
Laminated



**Frosted**  
8 mm TGH  
Satin Etch



**Grey Tinted**  
8 mm TGH  
Smoked glass

Any RAL Classic colours are available **plus 35% to prices above**. For both RAL and Glass Option together please add 65% to prices above.

# MATTE Colours



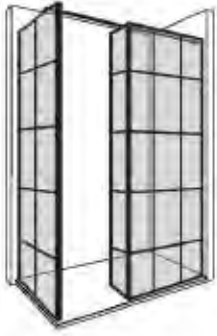

## Support Bars for Panel Combinations

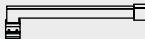

DRENCH Shower panels can be used individually or combined to recreate a walk-in shower space. When Shower panels are ordered individually support bars required for installation are included in the price and supplied by DRENCH.

When Shower Panels are combined, possibilities are endless hence we have designed a range of accessories suitable for any design or configuration.

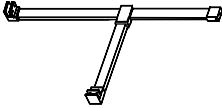
All support bars and fixings are supplied in same colour/finish as the Shower panel.

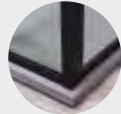
Item Code	Item Description	Specification	Retail Price Metallic Finishes (Exc VAT)
FXSBNGL..	<b>90° Angle Support Bar</b> (3 components, not pre-assembled) 450 mm length, 30 x 10 mm bar. **Not suitable for panels wider than 1000 mm**	 	£99
FXSBTBAR..	<b>T Shape Support bar</b> (4 components, not pre-assembled) 2x 30 x 10 mm bars. Long bar 1200 mm + Short bar at 1000 mm **Suitable for Shower Panels combinations**	 	£139
PR758..	<b>Corner Channel</b> for L Shape configurations Wall Fixings included. <b>2100 mm standard length</b>	 	£128

### Shower Panels Combinations Sample Layouts

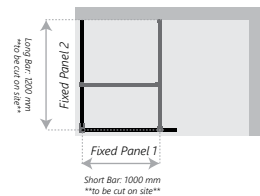
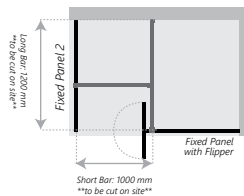
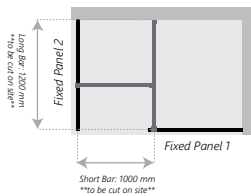

For Walk-In showers with Wall Fixed panels, **T Shape support bar (FXSBT-BAR..)** is recommended for installation purposes.

Please note the TBAR includes 2 bars at 1200 and 1000 mm. These bars can be trimmed on site to fit most of standard walk in shower dimensions.

For Walk-In showers with Wall Fixed panels and Fixed Panel with Flipper, **T Shape support bar (FXSBT-BAR..)** is recommended for installation purposes.

Please note the TBAR includes 2 bars at 1200 and 1000 mm. These bars can be trimmed on site to fit most of standard walk in shower dimensions.

For L-Shape configurations with Wall Fixed panels, **Corner channel (PR758)** and extra **T Shape support bar (FXSBT-BAR..)** is recommended for installation purposes.

Please note the TBAR includes 2 bars at 1200 and 1000 mm. These bars can be trimmed on site to fit most of standard walk in shower dimensions.



### Wall Fixed Panels

Panel is attached to the Wall using Wall Channel and Support Bar.

## Metallic Finishes





# FRAME Lite Metallic Finishes

## Wall Fixed Panels

Please choose your codes depending on width required and add the two letter colour code to it.





Prices below are RRP exc VAT for CLEAR GLASS, other GLASS OPTIONS are available plus additional surcharge.

Item Code	Description	Adjustment Range	Retail Price Exc VAT (Clear Glass)
FXLTE30..	Fixed Panel <b>300 mm x 2100 mm</b> <i>**No support Bar Included**</i>	275 - 290 mm	£1,005
FXLTE40..	Fixed Panel <b>400 mm x 2100 mm</b> <i>**No support Bar Included**</i>	375 - 390 mm	£1,083
FXLTE50..	Fixed Panel <b>500 mm x 2100 mm</b> <i>**FXSBCRS - Across Support Bar**</i>	475 - 490 mm	£1,166
FXLTE60..	Fixed Panel <b>600 mm x 2100 mm</b> <i>**FXSBCRS - Across Support Bar**</i>	575 - 590 mm	£1,249
FXLTE70..	Fixed Panel <b>700 mm x 2100 mm</b> <i>**FXSBCRS - Across Support Bar**</i>	675 - 690 mm	£1,332
FXLTE80..	Fixed Panel <b>800 mm x 2100 mm</b> <i>**FXSBCRS - Across Support Bar**</i>	775 - 790 mm	£1,798
FXLTE90..	Fixed Panel <b>900 mm x 2100 mm</b> <i>**FXSBCRS - Across Support Bar**</i>	875 - 890 mm	£1,897
FXLTE100..	Fixed Panel <b>1000 mm x 2100 mm</b> <i>**FXSBCRS - Across Support Bar**</i>	975 - 990 mm	£1,991
FXLTE120..	Fixed Panel <b>1200 mm x 2100 mm</b> <i>**FXSBCRS - Across Support Bar**</i>	1175 - 1190 mm	£2,061
FXLTE140..	Fixed Panel <b>1400 mm x 2100 mm</b> <i>**FXSBCRS - Across Support Bar**</i>	1375 - 1390 mm	£2,198

Please NOTE Support bars are included on price as per Product descriptions. For dimensions that do not fit our Standard range please contact us, we are experts on Bespoke and made to measure projects.

Please email us at [sales@drenchshowers.co.uk](mailto:sales@drenchshowers.co.uk).

### Metallic Finishes available

	LB	<b>Light Bronze</b>	Anodised
	DB	<b>Dark Bronze</b>	Anodised
	BS	<b>Brushed Steel</b>	Anodised
	BB	<b>Brushed Brass</b>	Anodised



**FXSBCRS**  
Across Support Bar  
1000 mm

### Metalwork Design layout

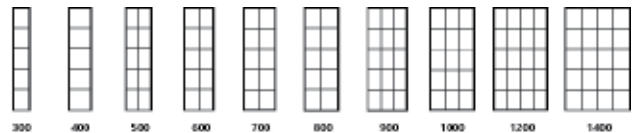

### Glass Options available

Please NOTE other Glass options are available plus additional surcharge to prices listed above.

Plus 45% additional

Plus 35% additional

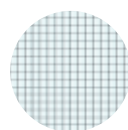

**Cross Fluted**  
8.8 mm TGH  
Laminated



**Fluted**  
8.8 mm TGH  
Laminated



**Frosted**  
8 mm TGH  
Satin Etch

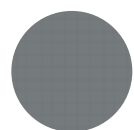

**Grey Tinted**  
8 mm TGH  
Smoked glass



## Fixed Panels with Flipper Panel

**Flipper panel is delivered already assembled to the fixed panel.**

It cannot be installed retrospectively.  
The pivot mechanism is adjustable from 0 de to 180 degree position.

## Metallic Finishes





# FRAME Lite Metallic Finishes

## Fixed Panels with Flipper

Please choose your codes depending on width required and add the two letter colour code to it.  
**NOTE This item is Handed so Left or Right Hand need to be specified.**



**LH**  
Left Hand



**RH**  
Right Hand

Item Code	Description	Adjustment Range	Retail Price Exc VAT (Clear Glass)
FXLTE30FLIPL.. FXLTE30FLIPR..	Fixed Panel <b>300 x 2100 mm with 300 Flipper.</b> R: Right Hand wall fixing / L: Left Hand wall fixing **FXSBCRS - Across Support Bar**	580 - 590 mm	£1,605
FXLTE40FLIPL.. FXLTE40FLIPR..	Fixed Panel <b>400 x 2100 mm with 300 Flipper.</b> R: Right Hand wall fixing / L: Left Hand wall fixing **FXSBCRS - Across Support Bar**	680 - 690 mm	£1,683
FXLTE50FLIPL.. FXLTE50FLIPR..	Fixed Panel <b>500 x 2100 mm with 300 Flipper.</b> R: Right Hand wall fixing / L: Left Hand wall fixing **FXSBCRS - Across Support Bar**	780 - 790 mm	£1,767
FXLTE60FLIPL.. FXLTE60FLIPR..	Fixed Panel <b>600 x 2100 mm with 300 Flipper.</b> R: Right Hand wall fixing / L: Left Hand wall fixing **FXSBCRS - Across Support Bar**	880 - 890 mm	£1,848
FXLTE70FLIPL.. FXLTE70FLIPR..	Fixed Panel <b>700 x 2100 mm with 300 Flipper.</b> R: Right Hand wall fixing / L: Left Hand wall fixing **FXSBCRS - Across Support Bar**	980 - 990 mm	£1,930
FXLTE80FLIPL.. FXLTE80FLIPR..	Fixed Panel <b>800 x 2100 mm with 300 Flipper.</b> R: Right Hand wall fixing / L: Left Hand wall fixing **FXSBCRS - Across Support Bar**	1080 - 1090 mm	£2,157
FXLTE90FLIPL.. FXLTE90FLIPR..	Fixed Panel <b>900 x 2100 mm with 300 Flipper.</b> R: Right Hand wall fixing / L: Left Hand wall fixing **FXSBCRS - Across Support Bar**	1180 - 1190 mm	£2,309
FXLTE100FLIPL.. FXLTE100FLIPR..	Fixed Panel <b>1000 x 2100 mm with 300 Flipper.</b> R: Right Hand wall fixing / L: Left Hand wall fixing **FXSBCRS - Across Support Bar**	1280 - 1290 mm	£2,394
FXLTE120FLIPL.. FXLTE120FLIPR..	Fixed Panel <b>1200 x 2100 mm with 300 Flipper.</b> R: Right Hand wall fixing / L: Left Hand wall fixing **FXSBCRS - Across Support Bar**	1480 - 1490 mm	£2,637
FXLTE140FLIPL.. FXLTE140FLIPR..	Fixed Panel <b>1400 x 2100 mm with 300 Flipper.</b> R: Right Hand wall fixing / L: Left Hand wall fixing **FXSBCRS - Across Support Bar**	1680 - 1690 mm	£2,794

Please NOTE Support bars are included on price as per Product descriptions.  
 For dimensions that do not fit our Standard range please email us at [sales@drenchshowers.co.uk](mailto:sales@drenchshowers.co.uk).

### Metallic Finishes available

	LB	<b>Light Bronze</b>	Anodised
	DB	<b>Dark Bronze</b>	Anodised
	BS	<b>Brushed Steel</b>	Anodised
	BB	<b>Brushed Brass</b>	Anodised



**FXSBCRS**  
Across Support Bar  
1000 mm

### Metalwork Design layout

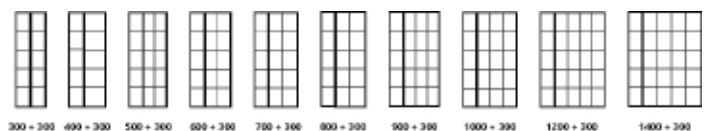

### Glass Options available

Please NOTE other Glass options are available plus additional surcharge to prices listed above.

Plus 45% additional

Plus 35% additional

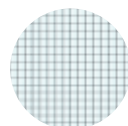

**Cross Fluted**

8.8 mm TGH  
Laminated



**Fluted**

8.8 mm TGH  
Laminated



**Frosted**

8 mm TGH  
Satin Etch

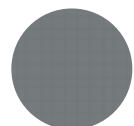

**Grey Tinted**

8 mm TGH  
Smoked glass

# FRAME Lite Metallic Finishes



## Free Standing Panels





**Free standing Shower Screen** for Wet rooms and walk-in showers.  
2 Across Support bars included in price.

Please add the two letter colour code to your code chosen above.

Item Code	Description	Physical width of Unit	Retail Price Exc VAT (Clear Glass)
FXLTE80FST..	Free Standing Panel <b>800 mm x 2100 mm</b> **2 x FXSBCRS - Across Support Bar**	762 mm	£1,798
FXLTE90FST..	Free Standing Panel <b>900 mm x 2100 mm</b> **2 x FXSBCRS - Across Support Bar**	862 mm	£1,897
FXLTE100FST..	Free Standing Panel <b>1000 mm x 2100 mm</b> **2 x FXSBCRS - Across Support Bar**	962 mm	£1,991
FXLTE120FST..	Free Standing Panel <b>1200 mm x 2100 mm</b> **2 x FXSBCRS - Across Support Bar**	1162 mm	£2,061
FXLTE140FST..	Free Standing Panel <b>1400 mm x 2100 mm</b> **2 x FXSBCRS - Across Support Bar**	1362 mm	£2,198

Please NOTE Support bars are included on price as per Product descriptions.  
For dimensions that do not fit our Standard range please contact us, we are experts on Bespoke and made to measure projects.  
Please email us at [sales@drenchshowers.co.uk](mailto:sales@drenchshowers.co.uk).

### Metallic Finishes available

	LB	<b>Light Bronze</b>	Anodised
	DB	<b>Dark Bronze</b>	Anodised
	BS	<b>Brushed Steel</b>	Anodised
	BB	<b>Brushed Brass</b>	Anodised



**FXSBCRS**  
Across Support Bar  
1000 mm

### Metalwork Design layout

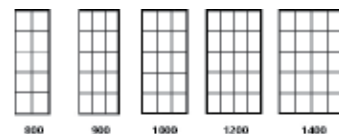

### Glass Options available

Please NOTE other Glass options are available plus additional surcharge to prices listed above.

Plus 45% additional

Plus 35% additional

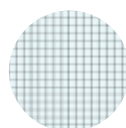

**Cross Fluted**  
8.8 mm TGH  
Laminated



**Fluted**  
8.8 mm TGH  
Laminated



**Frosted**  
8 mm TGH  
Satin Etch



**Grey Tinted**  
8 mm TGH  
Smoked glass







# Metallic Finishes

## Support Bars for Panel Combinations

DRENCH Shower panels can be used individually or combined to recreate a walk-in shower space. When Shower panels are ordered individually support bars required for installation are included in the price and supplied by DRENCH.

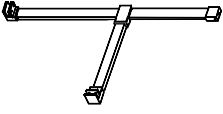
When Shower Panels are combined, possibilities are endless hence we have designed a range of accessories suitable for any design or configuration.

All support bars and fixings are supplied in same colour/finish as the Shower panel.

Item Code	Item Description	Specification	Retail Price Metallic Finishes (Exc VAT)
FXSBTBAR..	<b>T Shape Support bar</b> (4 components, not pre-assembled) 2x 30 x 10 mm bars. Long bar 1200 mm + Short bar at 1000 mm **Suitable for Shower Panels combinations**	 	<b>£235</b>
PR758..	<b>Corner Channel</b> for L Shape configurations Wall Fixings included. <b>2100 mm standard length</b>	 	<b>£213</b>

### Shower Panels Combinations Sample Layouts

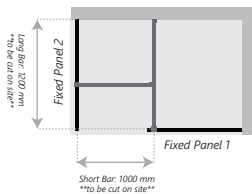

For Walk-In showers with Wall Fixed panels, **T Shape support bar (FXSBT-BAR..)** is recommended for installation purposes.

Please note the TBAR includes 2 bars at 1200 and 1000 mm.

These bars can be trimmed on site to fit most of standard walk in shower dimensions.

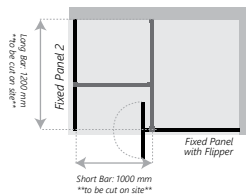

For Walk-In showers with Wall Fixed panels and Fixed Panel with Flipper, **T Shape support bar (FXSBTBAR..)** is recommended for installation purposes.

Please note the TBAR includes 2 bars at 1200 and 1000 mm.

These bars can be trimmed on site to fit most of standard walk in shower dimensions.

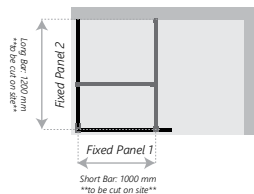

For L-Shape configurations with Wall Fixed panels, **Corner channel (PR758)** and extra **T Shape support bar (FXSBTBAR..)** is recommended for installation purposes.

Please note the TBAR includes 2 bars at 1200 and 1000 mm.

These bars can be trimmed on site to fit most of standard walk in shower dimensions.



## Bath Screens



**FRAME Lite**  
MATTE Colours

There is really nothing better than a nice long soak in the tub after a long and stressful day.

We love the idea we can contribute to make your bathtub look different with our range of Bath Screens.

DRENCH Bath Screens are available in pretty much all collections plus you can choose between 12 MATTE Colour options, 6 Metallic Finishes and our gorgeous glass options like Fluted, Frosted and Grey Tinted Glass.



**Fixed Bath Screen**  
Wall Fixed channel  
Included

**Fixed Bath screen** are a reduced version or our **Wall fixed** panels suitable to be installed onto a bath. This configuration ticks the box for small bathrooms.

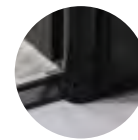

**Pivot hinged Bath Screen**

**Pivot Bath Screens** are hinged to the wall and swing **180 degrees**. Pivot bath screens are handed so make sure you choose the **Left or Right** hand code when ordering.

There is a 10 mm gap between the bottom profile and the top of the bath to allow the pivot mechanism work. A black rubber seal is supplied with the screen to cover the gap and guarantee watertight conditions.



# FRAME Lite MATTE Colours

## Bath Screens

**Both pivot and fixed bath screen options available.**  
Please add the two letter colour code to your code chosen above.

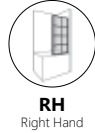
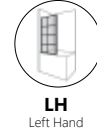

Item Code	Description	Adjustment Range	Retail Price Exc VAT (Clear Glass)
LTEFXBAT..	Fixed Bath Screen <b>800 x 1500 mm</b>	760 - 780 mm	£755
LTEBATL.. LTEBATR..	Pivot Hinged Bath Screen <b>800 x 1500 mm</b> L Left Hand / R Right Hand	760 - 780 mm	£835

For dimensions that do not fit our Standard range please contact us, we are experts on Bespoke and made to measure projects.  
Please email us at [sales@drenchshowers.co.uk](mailto:sales@drenchshowers.co.uk).

### MATTE Colours available

	BK	<b>Matt Black</b>	RAL9005
	GG	<b>Graphite Grey</b>	RAL7024
	GM	<b>Gun Metal</b>	RAL 8019
	BO	<b>Burnt Orange</b>	RAL 3022
	LY	<b>Lemon Yellow</b>	RAL 1012
	PP	<b>Pale Pink</b>	RAL 3015
	BL	<b>Blanc</b>	RAL 9002
	TT	<b>Total White</b>	RAL9003
	MI	<b>Mint</b>	RAL 6019
	FO	<b>Forest</b>	RAL 6009
	CB	<b>Capri Blue</b>	RAL 5019
	GN	<b>Grey Navy</b>	RAL 5008

### Metalwork Design layout



### Glass Options available

Please NOTE other Glass options are available plus additional surcharge to prices listed above.

Plus 45% additional

Plus 35% additional

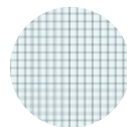

**Cross Fluted**  
8.8 mm TGH  
Laminated



**Fluted**  
8.8 mm TGH  
Laminated



**Frosted**  
8 mm TGH  
Satin Etch



**Grey Tinted**  
8 mm TGH  
Smoked glass

Any RAL Classic colours are available **plus 35% to prices above**. For both RAL and Glass Option together please add **65% to prices above**.



## Bath Screens

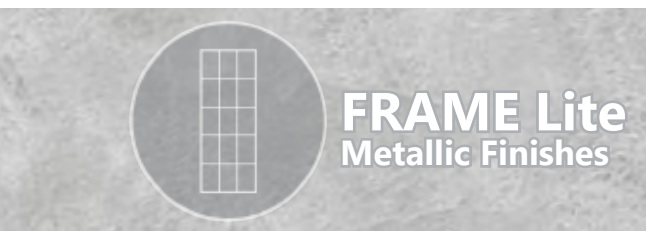

**FRAME Lite**  
Metallic Finishes

There is really nothing better than a nice long soak in the tub after a long and stressful day.

We love the idea we can contribute to make your bathtub look different with our range of Bath Screens.

DRENCH Bath Screens are available in pretty much all collections plus you can choose between 12 MATTE Colour options, 6 Metallic Finishes and our gorgeous glass options like Fluted, Frosted and Grey Tinted Glass.



**Fixed Bath Screen**  
Angle Support Included

**Fixed Bath screen** are a reduced version or our **Wall fixed** panels suitable to be installed onto a bath. This configuration ticks the box for small bathrooms.

Item includes angle **Support Bar(FXSBNGL)** on the price. Support Bar is installed in parallel to the panel.

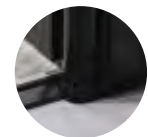

**Pivot hinged Bath Screen**

**Pivot Bath Screens** are hinged to the wall and swing **180 degrees**. Pivot bath screens are handed so make sure you choose the **Left or Right** hand code when ordering.

There is a 10 mm gap between the bottom profile and the top of the bath to allow the pivot mechanism work. A black rubber seal is supplied with the screen to cover the gap and guarantee watertight conditions.

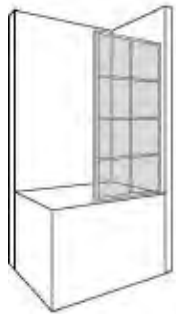

# FRAME Lite Metallic Finishes

## Bath Screens



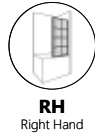
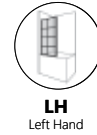

**Both pivot and fixed bath screen options available.**  
Please add the two letter colour code to your code chosen above.



Item Code	Description	Adjustment Range	Retail Price Exc VAT (Clear Glass)
LTEFXBAT..	Fixed Bath Screen <b>800 x 1500 mm</b>	760 - 780 mm	£1,077
LTEBATL.. LTEBATR..	Pivot Hinged Bath Screen <b>800 x 1500 mm</b> L Left Hand / R Right Hand	760 - 780 mm	£1,134

For dimensions that do not fit our Standard range please contact us, we are experts on Bespoke and made to measure projects.  
Please email us at [sales@drenchshowers.co.uk](mailto:sales@drenchshowers.co.uk).

### Metallic Finishes available

	LB	<b>Light Bronze</b>	Anodised
	DB	<b>Dark Bronze</b>	Anodised
	BS	<b>Brushed Steel</b>	Anodised
	BB	<b>Brushed Brass</b>	Anodised

### Metalwork Design layout



### Glass Options available

Please NOTE other Glass options are available plus additional surcharge to prices listed above.

Plus 45% additional

Plus 35% additional

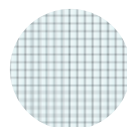

**Cross Fluted**  
8.8 mm TGH  
Laminated



**Fluted**  
8.8 mm TGH  
Laminated



**Frosted**  
8 mm TGH  
Satin Etch



**Grey Tinted**  
8 mm TGH  
Smoked glass

# Single Shower Doors



**FRAME Lite**  
**MATTE Colours**

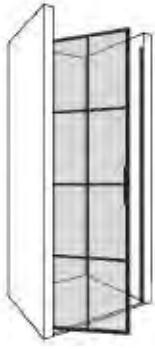

**LH**  
Left Hand

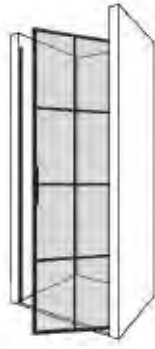

**RH**  
Right Hand

Single doors are suitable for shower recesses. **Left** or **Right** hand options are available.

Doors are built using our **pivot hinge**. The 5 mm rise and fall mechanism is manufactured using zinc die castings which give a durable and strong door performance. The **magnetic closing** creates a secure seal after the shower door is closed.

**Pull handle, fixings and door seal are included in the price below.**



Item Code	Description	Adjustment Range In a recess	Adjustment Range With Return Panel	Retail Price Exc VAT (Clear Glass)
LTEDOR70L... LTEDOR70R...	Shower Door <b>700 x 2100 mm</b> , L Left Hand / R Right Hand	667 - 699 mm	675 - 690 mm	£1,496
LTEDOR76L... LTEDOR76R...	Shower Door <b>760 x 2100 mm</b> , L Left Hand / R Right Hand	727 - 759 mm	735 - 750 mm	£1,544
LTEDOR80L... LTEDOR80R...	Shower Door <b>800 x 2100 mm</b> , L Left Hand / R Right Hand	767 - 799 mm	775 - 790 mm	£1,560
LTEDOR90L... LTEDOR90R...	Shower Door <b>900 x 2100 mm</b> , L Left Hand / R Right Hand	867 - 899 mm	875 - 890 mm	£1,609

Please choose your codes depending on width required and add the two letter colour code to it.

**NOTE This item is Handed so Left or Right Hand need to be specified.**

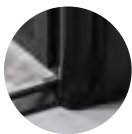

**Pivot hinge**

Our Pivot hinge system with a 5 mm rise and fall mechanism. **Pivot swing can be set from 0 to 180 degree position.**

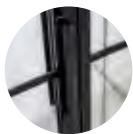

**PHAND**

Minimalistic pull handle. Mechanically fixed to Closing Post.

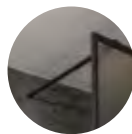

**FXSBCRS**

Across Support Bar 1000 mm

**\*\*When Door paired with Return Panel\*\***

**Metalwork Design layout**



700/760



800



900

# Return Panels for Shower Doors Enclosures

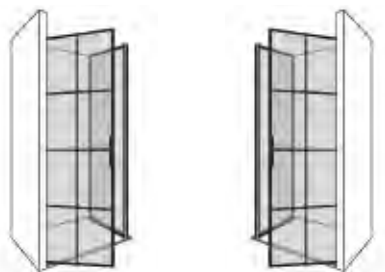

Shower doors may be paired with a range of Return/Side Panels to create Shower Cubicles. Return panels must be ordered with the door.  
If you want to create a Shower Enclosure please follow the steps below:

1. Choose your Door size, handing, colour and glass option and keep the code.
2. Choose the Return size check the hand required and keep the code. Our handing is based on the wall fixing position when you look at it from the outside.
3. Specify both codes on your order and DRENCH will make sure the correct Shower cubicle is delivered including wall fixings, handle and Support bars required.

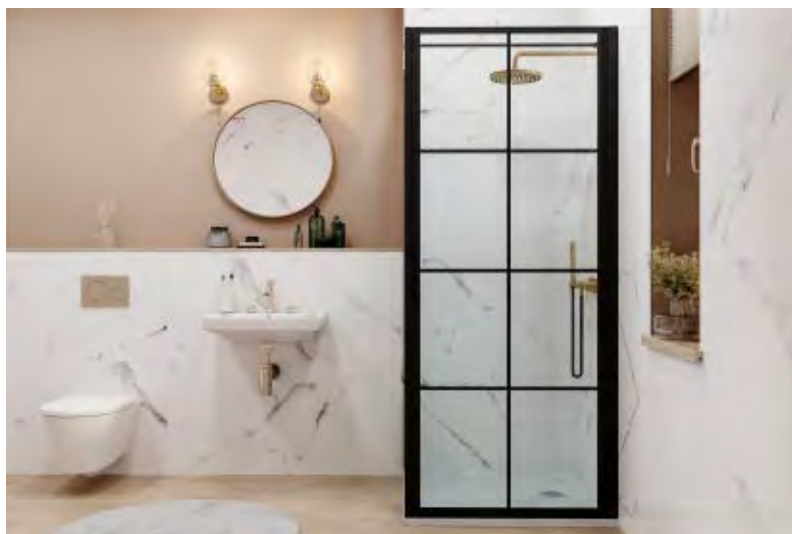

Item Code	Description	Adjustment Range	Retail Price Exc VAT (Clear Glass)
+LTE70L.. +LTE70R..	Return Panel <b>700 x 2100 mm</b> L Left Hand / R Right Hand <i>**FXSBCRS - Accross Support Bar**</i>	675 - 690 mm	£883
+LTE80L.. +LTE80R..	Return Panel <b>800 x 2100 mm</b> L Left Hand / R Right Hand <i>**FXSBCRS - Accross Support Bar**</i>	775 - 780 mm	£919
+LTE90L.. +LTE90R..	Return Panel <b>900 x 2100 mm</b> L Left Hand / R Right Hand <i>**FXSBCRS - Accross Support Bar**</i>	875 - 890 mm	£942
+LTE100L.. +LTE100R..	Return Panel <b>1000 x 2100 mm</b> L Left Hand / R Right Hand <i>**FXSBCRS - Accross Support Bar**</i>	975 - 990 mm	£1,005

For dimensions that do not fit our Standard range please contact us, we are experts on Bespoke and made to measure projects.  
Please email us at [sales@drenchshowers.co.uk](mailto:sales@drenchshowers.co.uk).

## MATTE Colours available

	BK	<b>Matt Black</b>	RAL 9005
	GG	<b>Graphite Grey</b>	RAL 7024
	GM	<b>Gun Metal</b>	RAL 8019
	BO	<b>Burnt Orange</b>	RAL 3022
	LY	<b>Lemon Yellow</b>	RAL 1012
	PP	<b>Pale Pink</b>	RAL 3015
	BL	<b>Blanc</b>	RAL 9002
	TT	<b>Total White</b>	RAL 9003
	MI	<b>Mint</b>	RAL 6019
	FO	<b>Forest</b>	RAL 6009
	CB	<b>Capri Blue</b>	RAL 5019
	GN	<b>Grey Navy</b>	RAL 5008

## Metalwork Design layout

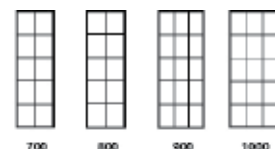

## Shower Door with Return Panel Configurations

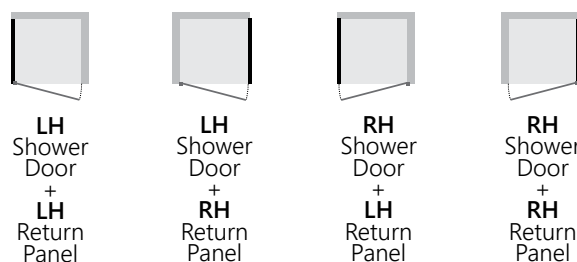

## Glass Options available

Please NOTE other Glass options are available plus additional surcharge to prices listed above.

Plus 45% additional		Plus 35% additional	
	<b>Cross Fluted</b> 8.8 mm TGH Laminated		<b>Fluted</b> 8.8 mm TGH Laminated
	<b>Frosted</b> 8 mm TGH Satin Etch		<b>Grey Tinted</b> 8 mm TGH Smoked glass

Any RAL Classic colours are available **plus 35% to prices above**. For both RAL and Glass Option together please add **65% to prices above**.

# Shower Door with Inline panel

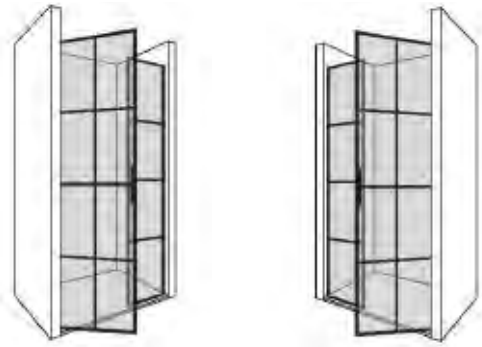

LH  
Left Hand

RH  
Right Hand

Door is hinged to the wall closing onto an Inline panel. Left or Right hand options are available.

Doors are built using our **pivot hinge**. The 5 mm rise and fall mechanism is manufactured using zinc die castings which give a durable and strong door performance. The **magnetic closing** creates a secure seal after the shower door is closed.

**Pull handle, fixings and door seal are included in the price below.**

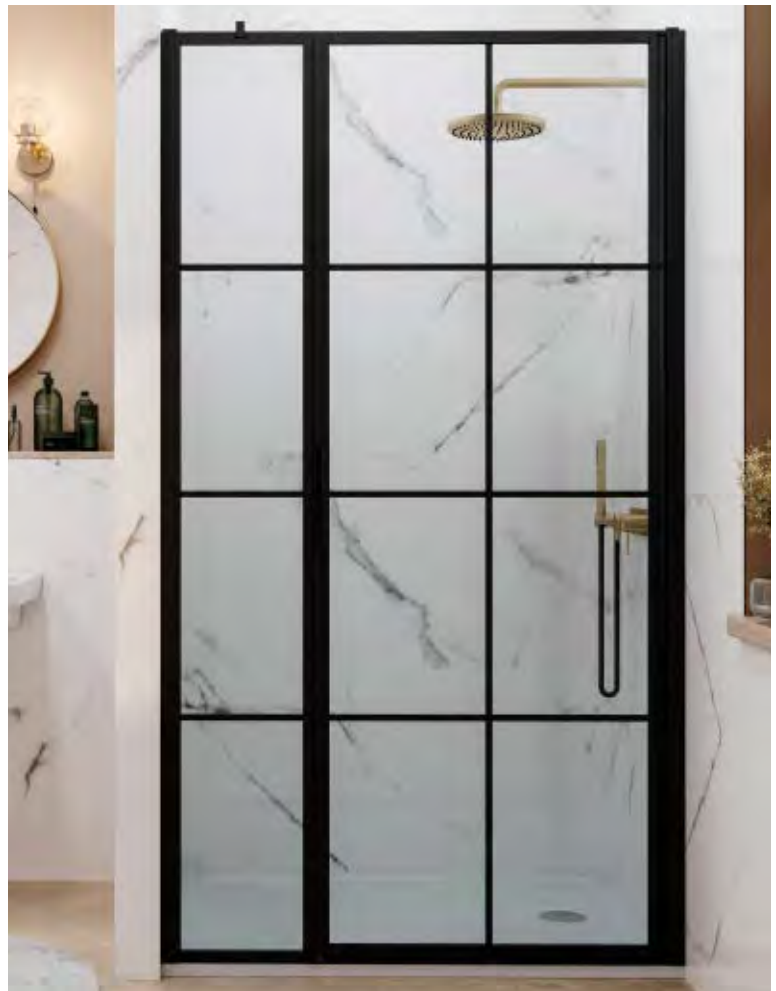

Item Code	Description	Adjustment Range	Adjustment Range	Retail Price Exc VAT (Clear Glass)
		In a recess	With Return Panel	
LTEDI70/20L... LTEDI70/20R...	Door with Inline <b>900 x 2100 mm</b> (700 mm Door + 200 mm Inline Panel) L Left Hand / R Right Hand <b>**FXSBPRL - Parallel Support Bar included**</b>	867 - 899 mm	875 - 890 mm	£1,889
LTEDI70/30L... LTEDI70/30R...	Door with Inline <b>1000 x 2100 mm</b> (700 mm Door + 300 mm Inline Panel) L Left Hand / R Right Hand <b>**FXSBPRL - Parallel Support Bar included**</b>	967 - 999 mm	975 - 990 mm	£1,946
LTEDI90/30L... LTEDI90/30R...	Door with Inline <b>1200 x 2100 mm</b> (900 mm Door + 300 mm Inline Panel) L Left Hand / R Right Hand <b>**FXSBPRL - Parallel Support Bar included**</b>	1167 - 1199 mm	1175 - 1190 mm	£1,870
LTEDI70/70L... LTEDI70/70R...	Door with Inline <b>1400 x 2100 mm</b> (700 mm Door + 700 mm Inline Panel) L Left Hand / R Right Hand <b>**FXSBPRL - Parallel Support Bar included**</b>	1367 - 1399 mm	1375 - 1390 mm	£2,348
LTEDI90/60L... LTEDI90/60R...	Door with Inline <b>1500 x 2100 mm</b> (900 mm Door + 600 mm Inline Panel) L Left Hand / R Right Hand <b>**FXSBPRL - Parallel Support Bar included**</b>	1467 - 1499 mm	1475 - 1490 mm	£2,439
LTEDI90/70L... LTEDI90/70R...	Door with Inline <b>1600 x 2100 mm</b> (900 mm Door + 700 mm Inline Panel) L Left Hand / R Right Hand <b>**FXSBPRL - Parallel Support Bar included**</b>	1567 - 1599 mm	1575 - 1590 mm	£2,755

All of our shower doors are Opening OUT, please contact us if Opening INWARDS is required. Please choose your codes depending on width required and add the two letter colour code to it.

**NOTE This item is Handed so Left or Right Hand need to be specified.**

## Metalwork Design layout

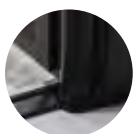

**Pivot hinge**

Our Pivot hinge system with a 5 mm rise and fall mechanism. **Pivot swing can be set from 0 to 180 degree position.**



**PHAND**

Minimalistic pull handle. Mechanically fixed to Closing Post.



**FXSBPRL**

Parallel Support Bar 2000 mm (To be trimmed on site)

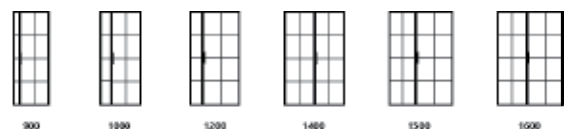

# Return Panels for Shower Door with Inline Enclosures

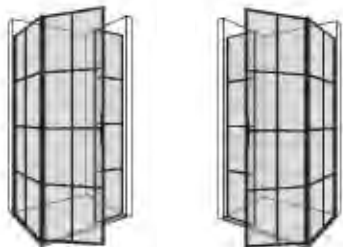

Shower doors with inline panel may be paired with a range of Return/Side Panels to create shower cubicles.

**Return panels must be ordered with the door.** If you want to create a Shower Enclosure please follow the steps below:

**1. Choose your Door with Inline size,** handing, colour and glass option and keep the code.

**2. Choose the Return size,** check the hand required and keep the code.

*\*\*Our handing is based on the wall fixing position when you look at it from the outside.\*\**

**3. Specify both codes** on your order and DRENCH will make sure the correct Shower cubicle is delivered including wall fixings, handle and Support bars required.



Item Code	Description	Adjustment Range	Retail Price Exc VAT (Clear Glass)
+LTE70L.. +LTE70R..	Return Panel <b>700 x 2100 mm</b> L Left Hand / R Right Hand <i>**FXSBDBL - Return Panel Support Bar**</i>	675 - 690 mm	£883
+LTE80L.. +LTE80R..	Return Panel <b>800 x 2100 mm</b> L Left Hand / R Right Hand <i>**FXSBDBL - Return Panel Support Bar**</i>	775 - 780 mm	£919
+LTE90L.. +LTE90R..	Return Panel <b>900 x 2100 mm</b> L Left Hand / R Right Hand <i>**FXSBDBL - Return Panel Support Bar**</i>	875 - 890 mm	£942
+LTE100L.. +LTE100R..	Return Panel <b>1000 x 2100 mm</b> L Left Hand / R Right Hand <i>**FXSBDBL - Return Panel Support Bar**</i>	975 - 990 mm	£1,005

*For dimensions that do not fit our Standard range please contact us, we are experts on Bespoke and made to measure projects. Please email us at [sales@drenchshowers.co.uk](mailto:sales@drenchshowers.co.uk).*

## MATTE Colours available

	BK	<b>Matt Black</b>	RAL 9005
	GG	<b>Graphite Grey</b>	RAL 7024
	GM	<b>Gun Metal</b>	RAL 8019
	BO	<b>Burnt Orange</b>	RAL 3022
	LY	<b>Lemon Yellow</b>	RAL 1012
	PP	<b>Pale Pink</b>	RAL 3015
	BL	<b>Blanc</b>	RAL 9002
	TT	<b>Total White</b>	RAL 9003
	MI	<b>Mint</b>	RAL 6019
	FO	<b>Forest</b>	RAL 6009
	CB	<b>Capri Blue</b>	RAL 5019
	GN	<b>Grey Navy</b>	RAL 5008



**FXSBDBL**  
Return panel Support Bar  
2000 mm

*\*\*Included\*\**

## Metalwork Design layout

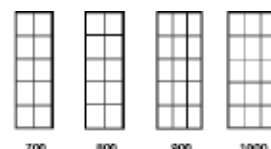

## Shower Door with Inline & Return Panel Configurations

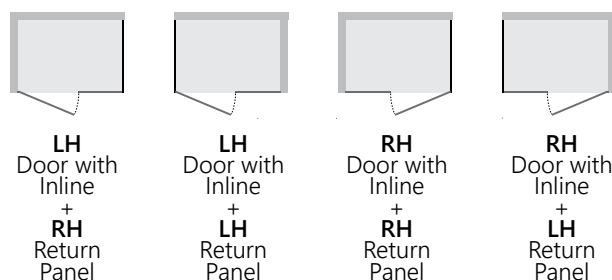

## Glass Options available

Please NOTE other Glass options are available plus additional surcharge to prices listed above.

Plus 45% additional		Plus 35% additional	
	<b>Cross Fluted</b> 8.8 mm TGH Laminated		<b>Fluted</b> 8.8 mm TGH Laminated
	<b>Frosted</b> 8 mm TGH Satin Etch		<b>Grey Tinted</b> 8 mm TGH Smoked glass

*Any RAL Classic colours are available plus 35% to prices above. For both RAL and Glass Option together please add 65% to prices above.*

# Shower Door hinged to Inline panel



**FRAME Lite**  
**MATTE Colours**



**LH**  
Left Hand



**RH**  
Right Hand

Shower Door is hinged to the Inline panel closing onto the wall. Left or Right hand options are available.

Doors are built using our **pivot hinge**. The 5 mm rise and fall mechanism is manufactured using zinc die castings which give a durable and strong door performance. The **magnetic closing** creates a secure seal after the shower door is closed.

**Pull handle, fixings and sealing components are included in prices below.**



Item Code	Description	Adjustment Range	Adjustment Range	Retail Price Exc VAT (Clear Glass)
		In a recess	With Return Panel	
LTEDH70/20L.. LTEDH70/20R..	Door hinged to Inline <b>900 x 2100 mm</b> (700 mm Door + 200 mm Inline Panel) L Left Hand / R Right Hand <i>**FXSBPRL - Parallel Support Bar included **</i>	869 - 899 mm	875 - 890 mm	£1,889
LTEDH70/30L.. LTEDH70/30R..	Door hinged to Inline <b>1000 x 2100 mm</b> (700 mm Door + 300 mm Inline Panel) L Left Hand / R Right Hand <i>**FXSBPRL - Parallel Support Bar included **</i>	969 - 999 mm	975 - 990 mm	£1,946
LTEDH90/30L.. LTEDH90/30R..	Door hinged to Inline <b>1200 x 2100 mm</b> (900 mm Door + 300 mm Inline Panel) L Left Hand / R Right Hand <i>**FXSBPRL - Parallel Support Bar included **</i>	1169 - 1199 mm	1175 - 1190 mm	£1,870
LTEDH70/70L.. LTEDH70/70R..	Door hinged to Inline <b>1400 x 2100 mm</b> (700 mm Door + 700 mm Inline Panel) L Left Hand / R Right Hand <i>**FXSBPRL - Parallel Support Bar included **</i>	1369 - 1399 mm	1375 - 1390 mm	£2,348
LTEDH90/60L.. LTEDH90/60R..	Door hinged to Inline <b>1500 x 2100 mm</b> (900 mm Door + 600 mm Inline Panel) L Left Hand / R Right Hand <i>**FXSBPRL - Parallel Support Bar included **</i>	1469 - 1499 mm	1475 - 1490 mm	£2,439
LTEDH90/70L.. LTEDH90/70R..	Door hinged to Inline <b>1600 x 2100 mm</b> (900 mm Door + 700 mm Inline Panel) L Left Hand / R Right Hand <i>**FXSBPRL - Parallel Support Bar included **</i>	1569 - 1599 mm	1575 - 1590 mm	£2,755

All of our shower doors are Opening OUT, please contact us if Opening INWARDS is required. Please choose your codes depending on width required and add the two letter colour code to it.

**NOTE This item is Handed so Left or Right Hand need to be specified.**

## Metalwork Design layout

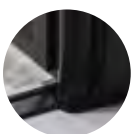

### Pivot hinge

Our Pivot hinge system with a 5 mm rise and fall mechanism. **Pivot swing can be set from 0 to 180 degree position.**



### PHAND

Minimalistic pull handle. Mechanically fixed to Closing Post.



### FXSBPRL

Parallel Support Bar 2000 mm (To be trimmed on site)

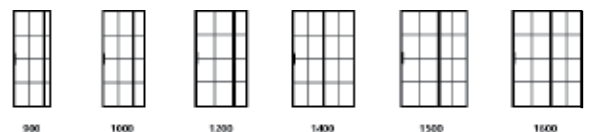

# Return Panels for Shower Door hinged to Inline Enclosures



Shower doors hinged to inline panel may be paired with a range of Return/Side Panels to create shower cubicles.

**Return panels must be ordered with the door.** If you want to create a Shower Enclosure please follow the steps below:

**1. Choose your Door hinged to Inline size,** handing, colour and glass option and keep the code.

**2. Choose the Return size,** check the hand required and keep the code.

*\*\*Our handing is based on the wall fixing position when you look at it from the outside.\*\**

**3. Specify both codes** on your order and DRENCH will make sure the correct Shower cubicle is delivered including wall fixings, handle and Support bars required.



Item Code	Description	Adjustment Range	Retail Price Exc VAT (Clear Glass)
+LTE70L.. +LTE70R..	Return Panel <b>700 x 2100 mm</b> L Left Hand / R Right Hand <i>**FXSBDBL - Return Panel Support Bar**</i>	675 - 690 mm	£883
+LTE80L.. +LTE80R..	Return Panel <b>800 x 2100 mm</b> L Left Hand / R Right Hand <i>**FXSBDBL - Return Panel Support Bar**</i>	775 - 780 mm	£919
+LTE90L.. +LTE90R..	Return Panel <b>900 x 2100 mm</b> L Left Hand / R Right Hand <i>**FXSBDBL - Return Panel Support Bar**</i>	875 - 890 mm	£942
+LTE100L.. +LTE100R..	Return Panel <b>1000 x 2100 mm</b> L Left Hand / R Right Hand <i>**FXSBDBL - Return Panel Support Bar**</i>	975 - 990 mm	£1,005

*For dimensions that do not fit our Standard range please contact us, we are experts on Bespoke and made to measure projects. Please email us at [sales@drenchshowers.co.uk](mailto:sales@drenchshowers.co.uk).*

## MATTE Colours available

	BK	<b>Matt Black</b>	RAL 9005
	GG	<b>Graphite Grey</b>	RAL 7024
	GM	<b>Gun Metal</b>	RAL 8019
	BO	<b>Burnt Orange</b>	RAL 3022
	LY	<b>Lemon Yellow</b>	RAL 1012
	PP	<b>Pale Pink</b>	RAL 3015
	BL	<b>Blanc</b>	RAL 9002
	TT	<b>Total White</b>	RAL 9003
	MI	<b>Mint</b>	RAL 6019
	FO	<b>Forest</b>	RAL 6009
	CB	<b>Capri Blue</b>	RAL 5019
	GN	<b>Grey Navy</b>	RAL 5008



**FXSBDBL**  
Return panel Support Bar  
2000 mm

*\*\*Included\*\**

## Metalwork Design layout



## Shower Door with Inline & Return Panel Configurations

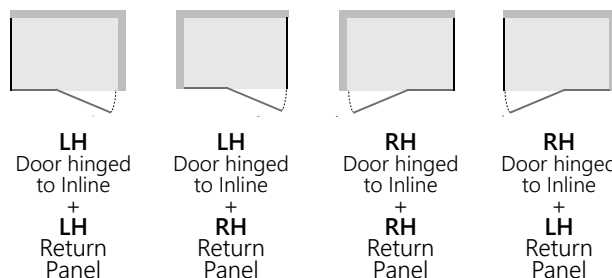

## Glass Options available

Please NOTE other Glass options are available plus additional surcharge to prices listed above.

Plus 45% additional		Plus 35% additional	
	<b>Cross Fluted</b> 8.8 mm TGH Laminated		<b>Fluted</b> 8.8 mm TGH Laminated
	<b>Frosted</b> 8 mm TGH Satin Etch		<b>Grey Tinted</b> 8 mm TGH Smoked glass

*Any RAL Classic colours are available plus 35% to prices above. For both RAL and Glass Option together please add 65% to prices above.*

# Single Shower Doors



## FRAME Lite Metallic Finishes

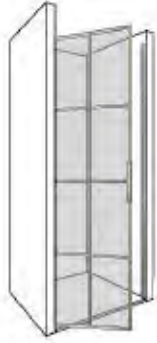

**LH**  
Left Hand



**RH**  
Right Hand

Single doors are suitable for shower recesses. **Left** or **Right** hand options are available.

Doors are built using our **vintage butt hinges**. Each door includes 4 hinges equally positioned and recessed on profiles. The **magnetic closing** creates a secure seal after the shower door is closed.

**Pull handle, fixings and door seal are included in the price below.**



Item Code	Description	Adjustment Range		Retail Price Exc VAT (Clear Glass)
		In a recess	With Return Panel	
LTEDOR70L.. LTEDOR70R..	Shower Door <b>700 x 2100 mm</b> , L Left Hand / R Right Hand	671 - 689 mm	681 - 690 mm	£1,749
LTEDOR76L.. LTEDOR76R..	Shower Door <b>760 x 2100 mm</b> , L Left Hand / R Right Hand	731 - 749 mm	739 - 747 mm	£2,210
LTEDOR80L.. LTEDOR80R..	Shower Door <b>800 x 2100 mm</b> , L Left Hand / R Right Hand	771 - 789 mm	781 - 790 mm	£2,246
LTEDOR90L.. LTEDOR90R..	Shower Door <b>900 x 2100 mm</b> , L Left Hand / R Right Hand	871 - 889 mm	881 - 890 mm	£2,255

Please choose your codes depending on width required and add the two letter colour code to it.

**NOTE This item is Handed so Left or Right Hand need to be specified.**



### Butt Hinge

Vintage butt hinges. Each door included 4 hinges equally positioned and recessed on profiles.



### SPHAND

Shaped pull handle. Mechanically fixed to Closing Post.



### FXSBCRS

Across Support Bar  
1000 mm

**\*\*When Door paired with Return Panel\*\***

### Metalwork Design layout



700/760



800



900

# Return Panels for Shower Doors Enclosures



Shower doors may be paired with a range of Return/Side Panels to create Shower Cubicles. Return panels must be ordered with the door.  
If you want to create a Shower Enclosure please follow the steps below:

1. Choose your Door size, handing, colour and glass option and keep the code.
2. Choose the Return size check the hand required and keep the code. Our handing is based on the wall fixing position when you look at it from the outside.
3. Specify both codes on your order and DRENCH will make sure the correct Shower cubicle is delivered including wall fixings, handle and Support bars required.



Item Code	Description	Adjustment Range	Retail Price Exc VAT (Clear Glass)
+LTE70L.. +LTE70R..	Return Panel <b>700 x 2100 mm</b> L Left Hand / R Right Hand <i>**FXSBCRS - Across Support Bar**</i>	675 - 690 mm	£1,154
+LTE80L.. +LTE80R..	Return Panel <b>800 x 2100 mm</b> L Left Hand / R Right Hand <i>**FXSBCRS - Across Support Bar**</i>	775 - 780 mm	£1,241
+LTE90L.. +LTE90R..	Return Panel <b>900 x 2100 mm</b> L Left Hand / R Right Hand <i>**FXSBCRS - Across Support Bar**</i>	875 - 890 mm	£1,318
+LTE100L.. +LTE100R..	Return Panel <b>1000 x 2100 mm</b> L Left Hand / R Right Hand <i>**FXSBCRS - Across Support Bar**</i>	975 - 990 mm	£1,407

For dimensions that do not fit our Standard range please contact us, we are experts on Bespoke and made to measure projects.  
Please email us at [sales@drenchshowers.co.uk](mailto:sales@drenchshowers.co.uk).

## Metallic Finishes available

	LB	<b>Light Bronze</b>	Anodised
	DB	<b>Dark Bronze</b>	Anodised
	BS	<b>Brushed Steel</b>	Anodised
	BB	<b>Brushed Brass</b>	Anodised

## Metalwork Design layout

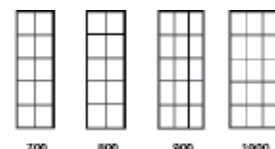

## Shower Door with Return Panel Configurations

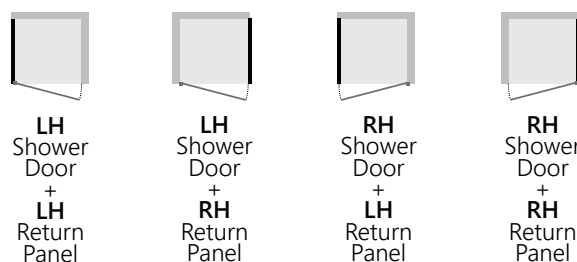

## Glass Options available

Please NOTE other Glass options are available plus additional surcharge to prices listed above.

Plus 45% additional		Plus 35% additional	
	<b>Cross Fluted</b> 8.8 mm TGH Laminated		<b>Fluted</b> 8.8 mm TGH Laminated
	<b>Frosted</b> 8 mm TGH Satin Etch		<b>Grey Tinted</b> 8 mm TGH Smoked glass

# Shower Door with Inline panel



**FRAME Lite**  
Metallic Finishes



**LH**  
Left Hand



**RH**  
Right Hand

Door is hinged to the wall closing onto an Inline panel. Left or Right hand options are available.

Doors are built using 4 vintage ball bearing hinges finished in the metal chosen. The magnetic closing creates a secure seal after the shower door is closed.

Pull handle, fixings and door seal are included in the price below.



Item Code	Description	Adjustment Range	Adjustment Range	Retail Price Exc VAT (Clear Glass)
		In a recess	With Return Panel	
LTEDI70/20L.. LTEDI70/20R..	Door with Inline <b>900 x 2100 mm</b> (700 mm Door + 200 mm Inline Panel) L Left Hand / R Right Hand <b>**FXSBPRL - Parallel Support Bar included**</b>	871 - 889 mm	881 - 890 mm	£2,331
LTEDI70/30L.. LTEDI70/30R..	Door with Inline <b>1000 x 2100 mm</b> (700 mm Door + 300 mm Inline Panel) L Left Hand / R Right Hand <b>**FXSBPRL - Parallel Support Bar included**</b>	971 - 989 mm	981 - 990 mm	£2,600
LTEDI90/30L.. LTEDI90/30R..	Door with Inline <b>1200 x 2100 mm</b> (900 mm Door + 300 mm Inline Panel) L Left Hand / R Right Hand <b>**FXSBPRL - Parallel Support Bar included**</b>	1171 - 1189 mm	1181 - 1190 mm	£2,798
LTEDI70/70L.. LTEDI70/70R..	Door with Inline <b>1400 x 2100 mm</b> (700 mm Door + 700 mm Inline Panel) L Left Hand / R Right Hand <b>**FXSBPRL - Parallel Support Bar included**</b>	1371 - 1389 mm	1381 - 1390 mm	£3,065
LTEDI90/60L.. LTEDI90/60R..	Door with Inline <b>1500 x 2100 mm</b> (900 mm Door + 600 mm Inline Panel) L Left Hand / R Right Hand <b>**FXSBPRL - Parallel Support Bar included**</b>	1471 - 1489 mm	1481 - 1490 mm	£3,171
LTEDI90/70L.. LTEDI90/70R..	Door with Inline <b>1600 x 2100 mm</b> (900 mm Door + 700 mm Inline Panel) L Left Hand / R Right Hand <b>**FXSBPRL - Parallel Support Bar included**</b>	1571 - 1589 mm	1581 - 1590 mm	£3,231

All of our shower doors are Opening OUT, please contact us if Opening INWARDS is required. Please choose your codes depending on width required and add the two letter colour code to it. **NOTE This item is Handed so Left or Right Hand need to be specified.**

## Metalwork Design layout



**Butt Hinge**

Vintage butt hinges. Each door included 4 hinges equally positioned and recessed on profiles.



**SPHAND**

Shaped pull handle. Mechanically fixed to Closing Post.



**FXSBPRL**

Parallel Support Bar 2000 mm (To be trimmed on site)

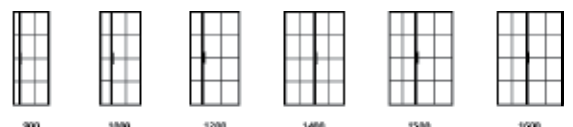

# Return Panels for Shower Door with Inline Enclosures



Shower doors with inline panel may be paired with a range of Return/Side Panels to create shower cubicles. **Return panels must be ordered with the door.** If you want to create a Shower Enclosure please follow the steps below:

**1. Choose your Door with Inline size,** handing, colour and glass option and keep the code.

**2. Choose the Return size,** check the hand required and keep the code.

*\*\*Our handing is based on the wall fixing position when you look at it from the outside.\*\**

**3. Specify both codes** on your order and DRENCH will make sure the correct Shower cubicle is delivered including wall fixings, handle and Support bars required.



Item Code	Description	Adjustment Range	Retail Price Exc VAT (Clear Glass)
+LTE70L.. +LTE70R..	Return Panel <b>700 x 2100 mm</b> L Left Hand / R Right Hand <i>**FXSBDBL - Return Panel Support Bar**</i>	675 - 690 mm	£1,154
+LTE80L.. +LTE80R..	Return Panel <b>800 x 2100 mm</b> L Left Hand / R Right Hand <i>**FXSBDBL - Return Panel Support Bar**</i>	775 - 780 mm	£1,241
+LTE90L.. +LTE90R..	Return Panel <b>900 x 2100 mm</b> L Left Hand / R Right Hand <i>**FXSBDBL - Return Panel Support Bar**</i>	875 - 890 mm	£1,318
+LTE100L.. +LTE100R..	Return Panel <b>1000 x 2100 mm</b> L Left Hand / R Right Hand <i>**FXSBDBL - Return Panel Support Bar**</i>	975 - 990 mm	£1,407

*For dimensions that do not fit our Standard range please contact us, we are experts on Bespoke and made to measure projects. Please email us at [sales@drenchshowers.co.uk](mailto:sales@drenchshowers.co.uk).*

## Metallic Finishes available

	LB	<b>Light Bronze</b>	Anodised
	DB	<b>Dark Bronze</b>	Anodised
	BS	<b>Brushed Steel</b>	Anodised
	BB	<b>Brushed Brass</b>	Anodised

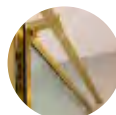

**FXSBDBL**  
Return panel Support Bar  
2000 mm

*\*\*Included\*\**

## Metalwork Design layout

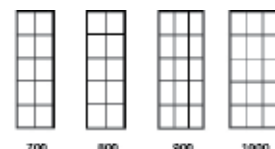

## Shower Door with Inline & Return Panel Configurations

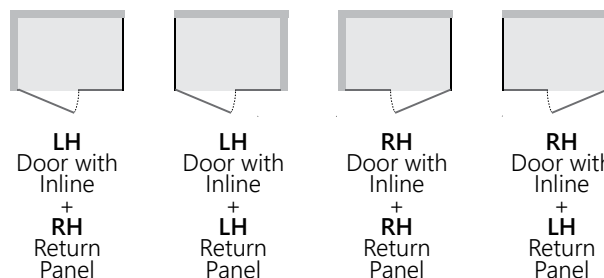

## Glass Options available

Please NOTE other Glass options are available plus additional surcharge to prices listed above.

Plus 45% additional		Plus 35% additional	
	<b>Cross Fluted</b> 8.8 mm TGH Laminated		<b>Fluted</b> 8.8 mm TGH Laminated
	<b>Frosted</b> 8 mm TGH Satin Etch		<b>Grey Tinted</b> 8 mm TGH Smoked glass

*Any RAL Classic colours are available plus 35% to prices above. For both RAL and Glass Option together please add 65% to prices above.*

# Shower Door hinged to Inline panel



**FRAME Lite**  
Metallic Finishes



**LH**  
Left Hand



**RH**  
Right Hand

Shower Door is hinged to the Inline panel closing onto the wall. Left or Right hand options are available.

Doors are built using 4 vintage ball bearing hinges finished in the metal chosen. The magnetic closing creates a secure seal after the shower door is closed.

Pull handle, fixings and door seal are included in the price below.



Item Code	Description	Adjustment Range	Adjustment Range	Retail Price Exc VAT (Clear Glass)
		In a recess	With Return Panel	
LTEDH70/20L.. LTEDH70/20R..	Door hinged to Inline <b>900 x 2100 mm</b> (700 mm Door + 200 mm Inline Panel) L Left Hand / R Right Hand <i>**FXSBPRL - Parallel Support Bar included **</i>	871 - 889 mm	875 - 890 mm	£2,331
LTEDH70/30L.. LTEDH70/30R..	Door hinged to Inline <b>1000 x 2100 mm</b> (700 mm Door + 300 mm Inline Panel) L Left Hand / R Right Hand <i>**FXSBPRL - Parallel Support Bar included **</i>	971 - 989 mm	975 - 990 mm	£2,600
LTEDH90/30L.. LTEDH90/30R..	Door hinged to Inline <b>1200 x 2100 mm</b> (900 mm Door + 300 mm Inline Panel) L Left Hand / R Right Hand <i>**FXSBPRL - Parallel Support Bar included **</i>	1171 - 1189 mm	1175 - 1190 mm	£2,798
LTEDH70/70L.. LTEDH70/70R..	Door hinged to Inline <b>1400 x 2100 mm</b> (700 mm Door + 700 mm Inline Panel) L Left Hand / R Right Hand <i>**FXSBPRL - Parallel Support Bar included **</i>	1371 - 1389 mm	1375 - 1390 mm	£3,065
LTEDH90/60L.. LTEDH90/60R..	Door hinged to Inline <b>1500 x 2100 mm</b> (900 mm Door + 600 mm Inline Panel) L Left Hand / R Right Hand <i>**FXSBPRL - Parallel Support Bar included **</i>	1471 - 1489 mm	1475 - 1490 mm	£3,171
LTEDH90/70L.. LTEDH90/70R..	Door hinged to Inline <b>1600 x 2100 mm</b> (900 mm Door + 700 mm Inline Panel) L Left Hand / R Right Hand <i>**FXSBPRL - Parallel Support Bar included **</i>	1571 - 1589 mm	1575 - 1590 mm	£3,231

All of our shower doors are Opening OUT, please contact us if Opening INWARDS is required. Please choose your codes depending on width required and add the two letter colour code to it.

**NOTE This item is Handed so Left or Right Hand need to be specified.**

## Metalwork Design layout



**Butt Hinge**

Vintage butt hinges. Each door included 4 hinges equally positioned and recessed on profiles.



**SPHAND**

Shaped pull handle. Mechanically fixed to Closing Post.



**FXSBPRL**

Parallel Support Bar 2000 mm (To be trimmed on site)

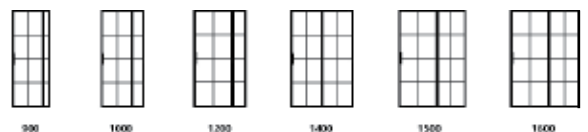



# Return Panels for Shower Door hinged to Inline Enclosures

Shower doors hinged to inline panel may be paired with a range of Return/Side Panels to create shower cubicles.

**Return panels must be ordered with the door.** If you want to create a Shower Enclosure please follow the steps below:

**1. Choose your Door hinged to Inline size,** handing, colour and glass option and keep the code.

**2. Choose the Return size,** check the hand required and keep the code.

*\*\*Our handing is based on the wall fixing position when you look at it from the outside.\*\**

**3. Specify both codes** on your order and DRENCH will make sure the correct Shower cubicle is delivered including wall fixings, handle and Support bars required.



Item Code	Description	Adjustment Range	Retail Price Exc VAT (Clear Glass)
+LTE70L.. +LTE70R..	Return Panel <b>700 x 2100 mm</b> L Left Hand / R Right Hand <i>**FXSDBL - Return Panel Support Bar**</i>	675 - 690 mm	£1,154
+LTE80L.. +LTE80R..	Return Panel <b>800 x 2100 mm</b> L Left Hand / R Right Hand <i>**FXSDBL - Return Panel Support Bar**</i>	775 - 780 mm	£1,241
+LTE90L.. +LTE90R..	Return Panel <b>900 x 2100 mm</b> L Left Hand / R Right Hand <i>**FXSDBL - Return Panel Support Bar**</i>	875 - 890 mm	£1,318
+LTE100L.. +LTE100R..	Return Panel <b>1000 x 2100 mm</b> L Left Hand / R Right Hand <i>**FXSDBL - Return Panel Support Bar**</i>	975 - 990 mm	£1,407

*For dimensions that do not fit our Standard range please contact us, we are experts on Bespoke and made to measure projects. Please email us at [sales@drenchshowers.co.uk](mailto:sales@drenchshowers.co.uk).*

## Metallic Finishes available

	LB	<b>Light Bronze</b>	Anodised
	DB	<b>Dark Bronze</b>	Anodised
	BS	<b>Brushed Steel</b>	Anodised
	BB	<b>Brushed Brass</b>	Anodised



**FXSDBL**  
Return panel Support Bar  
2000 mm

*\*\*Included\*\**

## Metalwork Design layout

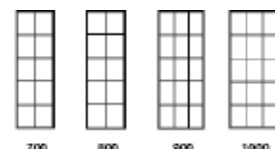

## Shower Door with Inline & Return Panel Configurations

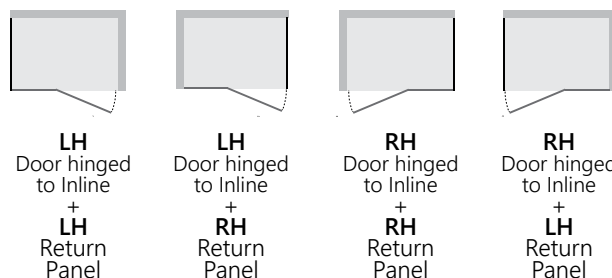

## Glass Options available

Please NOTE other Glass options are available plus additional surcharge to prices listed above.

Plus 45% additional		Plus 35% additional	
	<b>Cross Fluted</b> 8.8 mm TGH Laminated		<b>Fluted</b> 8.8 mm TGH Laminated
	<b>Frosted</b> 8 mm TGH Satin Etch		<b>Grey Tinted</b> 8 mm TGH Smoked glass

*Any RAL Classic colours are available plus 35% to prices above. For both RAL and Glass Option together please add 65% to prices above.*



*Single Shower Door 900 x 2100 closing into Return panel 900 x 2100 mm  
Graphite Grey, Frosted Glass*



# SUZHOU

Collection





# SUZHOU Collection

## FEATURES:

*ALL Product configurations*

*2100 mm Height*

*19 mm of Adjustment*

*12 MATTE Colours & 4 Metallic Finishes*

*8 mm Toughened Glass*

*(Fluted, Frosted, Grey Tinted & Clear Glass options)*

*Easy Clean Coating*

SUZHOU Collection is inspired by the use of Asian and oriental shapes in interior design and keeping the unique DRENCH bold look.

Suzhou, a city west of Shanghai, is known for its canals, bridges and classical gardens as well as for its high & new technology development zone.

SUZHOU collection is available for all DRENCH ranges including Panels, Bath Screens, Shower Doors & Shower Enclosures.

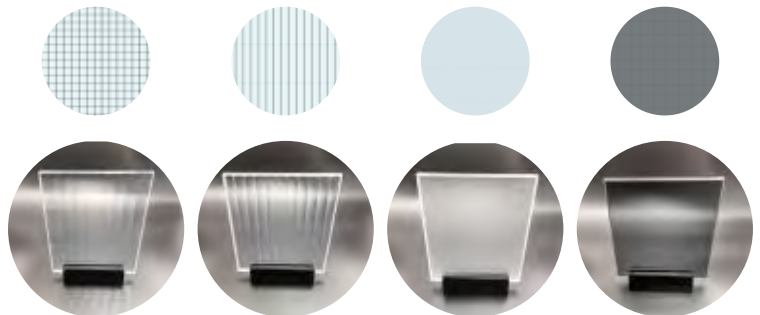
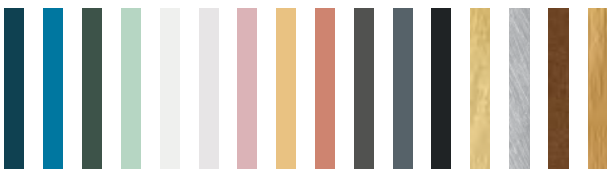

**Cross Fluted**

8.8 mm TGH Laminated

**Fluted**

8.8 mm TGH Laminated

**Frosted**

8 mm TGH Satin Etch

**Grey Tinted**







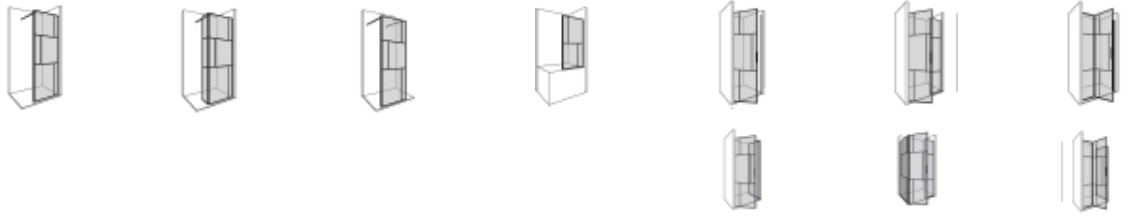

8 mm TGH Smoked glass



**Product Configurations Available**



**Standard Dimensions Vs Product Configuration**

	300	400	500	600	700	800	900	1000	1200	1400	1500	1600
 <b>Wall Fixed Panels</b> Standard Height 2100 mm											✗	✗
 <b>Wall Fixed Panels with Flipper Panel</b> Standard Height 2100 mm											✗	✗
 <b>Free Standing Panels</b> Standard Height 2100 mm	✗	✗	✗	✗	✗						✗	✗
 <b>Single Shower Doors</b> Standard Height 2100 mm	✗	✗	✗	✗				✗	✗	✗	✗	✗
 <b>Shower Doors with Inline Panel</b> Standard Height 2100 mm	✗	✗	✗	✗	✗	✗						
 <b>Shower Doors hinged to Inline Panel</b> Standard Height 2100 mm	✗	✗	✗	✗	✗	✗						
 <b>Return Panels for Shower Enclosures</b> Standard Height 2100 mm	✗	✗	✗	✗					✗	✗	✗	✗
 <b>Bath Screens (Pivot &amp; Fixed)</b> Standard Height 1500 mm	✗	✗	✗	✗	✗		✗	✗	✗	✗	✗	✗





## Wall Fixed Panels

Panel is attached to the Wall using Wall Channel and Support Bar.

# MATTE Colours

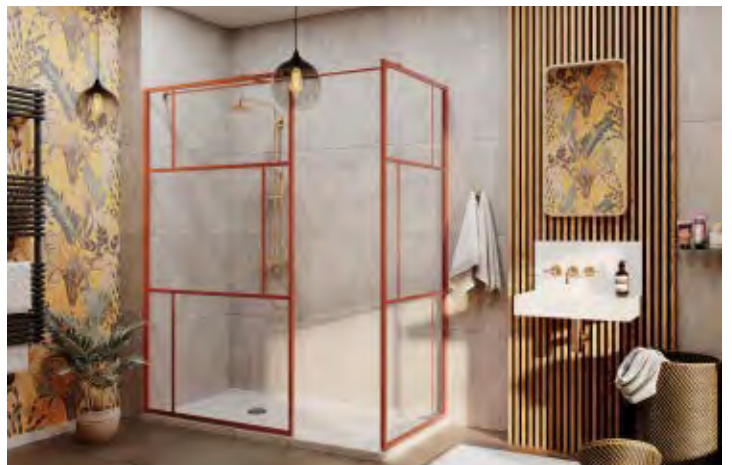

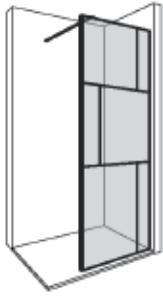

# SUZHOU MATTE Colours

## Wall Fixed Panels

Please choose your codes depending on width required and add the two letter colour code to it. Prices below are RRP exc VAT for CLEAR GLASS, other GLASS OPTIONS are available plus additional surcharge.



LH  
Left Hand



RH  
Right Hand

**NOTE This item is Handed so Left or Right Hand need to be specified.**

Item Code	Description	Adjustment Range	Retail Price Exc VAT (Clear Glass)
FXSUZ30L.. FXSUZ30R..	Fixed Panel <b>300 mm x 2100 mm.</b> L Left Hand Wall Fixed. R Right Hand Wall Fixed. <b>**No support Bar Included**</b>	275 - 290 mm	<b>£781</b>
FXSUZ40L.. FXSUZ40R..	Fixed Panel <b>400 mm x 2100 mm</b> L Left Hand Wall Fixed. R Right Hand Wall Fixed. <b>**No support Bar Included**</b>	375 - 390 mm	<b>£820</b>
FXSUZ50L.. FXSUZ50R..	Fixed Panel <b>500 mm x 2100 mm</b> L Left Hand Wall Fixed. R Right Hand Wall Fixed. <b>**FXSBNGL - Angle Support Bar**</b>	475 - 490 mm	<b>£844</b>
FXSUZ60L.. FXSUZ60R..	Fixed Panel <b>600 mm x 2100 mm</b> L Left Hand Wall Fixed. R Right Hand Wall Fixed. <b>**FXSBNGL - Angle Support Bar**</b>	575 - 590 mm	<b>£906</b>
FXSUZ70L.. FXSUZ70R..	Fixed Panel <b>700 mm x 2100 mm</b> L Left Hand Wall Fixed. R Right Hand Wall Fixed. <b>**FXSBNGL - Angle Support Bar**</b>	675 - 690 mm	<b>£970</b>
FXSUZ80L.. FXSUZ80R..	Fixed Panel <b>800 mm x 2100 mm</b> L Left Hand Wall Fixed. R Right Hand Wall Fixed. <b>**FXSBCRS - Across Support Bar**</b>	775 - 790 mm	<b>£1,030</b>
FXSUZ90L.. FXSUZ90R..	Fixed Panel <b>900 mm x 2100 mm</b> L Left Hand Wall Fixed. R Right Hand Wall Fixed. <b>**FXSBCRS - Across Support Bar**</b>	875 - 890 mm	<b>£1,079</b>
FXSUZ100L.. FXSUZ100R..	Fixed Panel <b>1000 mm x 2100 mm</b> L Left Hand Wall Fixed. R Right Hand Wall Fixed. <b>**FXSBCRS - Across Support Bar**</b>	975 - 990 mm	<b>£1,126</b>
FXSUZ120L.. FXSUZ120R..	Fixed Panel <b>1200 mm x 2100 mm</b> L Left Hand Wall Fixed. R Right Hand Wall Fixed. <b>**FXSBCRS - Across Support Bar**</b>	1175 - 1190 mm	<b>£1,223</b>
FXSUZ140L.. FXSUZ140R..	Fixed Panel <b>1400 mm x 2100 mm</b> L Left Hand Wall Fixed. R Right Hand Wall Fixed. <b>**FXSBCRS - Across Support Bar**</b>	1375 - 1390 mm	<b>£1,320</b>

Please NOTE Support bars are included on price as per Product descriptions. For dimensions that do not fit our Standard range please contact us, we are experts on Bespoke and made to measure projects.

Please email us at [sales@drenchshowers.co.uk](mailto:sales@drenchshowers.co.uk).

### MATTE Colours available

	BK	<b>Matt Black</b>	RAL 9005
	GG	<b>Graphite Grey</b>	RAL 7024
	GM	<b>Gun Metal</b>	RAL 8019
	BO	<b>Burnt Orange</b>	RAL 3022
	LY	<b>Lemon Yellow</b>	RAL 1012
	PP	<b>Pale Pink</b>	RAL 3015
	BL	<b>Blanc</b>	RAL 9002
	TT	<b>Total White</b>	RAL 9003
	MI	<b>Mint</b>	RAL 6019
	FO	<b>Forest</b>	RAL 6009
	CB	<b>Capri Blue</b>	RAL 5019
	GN	<b>Grey Navy</b>	RAL 5008

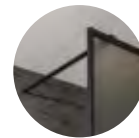

**FXSBCRS**  
Across Support Bar  
1000 mm



**FXSBNGL**  
Angle Support Bar  
450 mm

### Metalwork Design layout

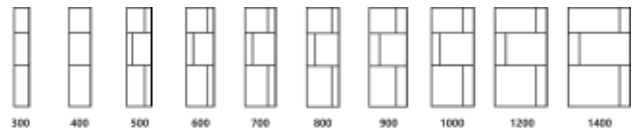

### Glass Options available

Please NOTE other Glass options are available plus additional surcharge to prices listed above.

Plus 45% additional

Plus 35% additional

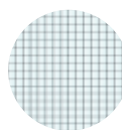

**Cross Fluted**  
8.8 mm TGH  
Laminated



**Fluted**  
8.8 mm TGH  
Laminated



**Frosted**  
8 mm TGH  
Satin Etch

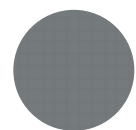

**Grey Tinted**  
8 mm TGH  
Smoked glass

Any RAL Classic colours are available **plus 35% to prices above**. For both RAL and Glass Option together please add **65% to prices above**.



## Fixed Panels with Flipper Panel

**Flipper panel is delivered already assembled to the fixed panel.**

It cannot be installed retrospectively.  
The pivot mechanism is adjustable from 0 de to 180 degree position.

# MATTE Colours



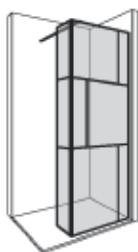

# SUZHOU MATTE Colours

## Fixed Panels with Flipper

Please choose your codes depending on width required and add the two letter colour code to it.

**NOTE This item is Handed so Left or Right Hand need to be specified.**



**LH**  
Left Hand



**RH**  
Right Hand

Item Code	Description	Adjustment Range	Retail Price Exc VAT (Clear Glass)
FXSUZ30FLIPL.. FXSUZ30FLIPR..	Fixed Panel <b>300 x 2100 mm with 300 Flipper.</b> R: Right Hand wall fixing / L: Left Hand wall fixing **FXSBNGL - Angle Support Bar**	580 - 590 mm	£997
FXSUZ40FLIPL.. FXSUZ40FLIPR..	Fixed Panel <b>400 x 2100 mm with 300 Flipper.</b> R: Right Hand wall fixing / L: Left Hand wall fixing **FXSBNGL - Angle Support Bar**	680 - 690 mm	£1,049
FXSUZ50FLIPL.. FXSUZ50FLIPR..	Fixed Panel <b>500 x 2100 mm with 300 Flipper.</b> R: Right Hand wall fixing / L: Left Hand wall fixing **FXSBCRS - Across Support Bar**	780 - 790 mm	£1,076
FXSUZ60FLIPL.. FXSUZ60FLIPR..	Fixed Panel <b>600 x 2100 mm with 300 Flipper.</b> R: Right Hand wall fixing / L: Left Hand wall fixing **FXSBCRS - Across Support Bar**	880 - 890 mm	£1,093
FXSUZ70FLIPL.. FXSUZ70FLIPR..	Fixed Panel <b>700 x 2100 mm with 300 Flipper.</b> R: Right Hand wall fixing / L: Left Hand wall fixing **FXSBCRS - Across Support Bar**	980 - 990 mm	£1,143
FXSUZ80FLIPL.. FXSUZ80FLIPR..	Fixed Panel <b>800 x 2100 mm with 300 Flipper.</b> R: Right Hand wall fixing / L: Left Hand wall fixing **FXSBCRS - Across Support Bar**	1080 - 1090 mm	£1,278
FXSUZ90FLIPL.. FXSUZ90FLIPR..	Fixed Panel <b>900 x 2100 mm with 300 Flipper.</b> R: Right Hand wall fixing / L: Left Hand wall fixing **FXSBCRS - Across Support Bar**	1180 - 1190 mm	£1,318
FXSUZ100FLIPL.. FXSUZ100FLIPR..	Fixed Panel <b>1000 x 2100 mm with 300 Flipper.</b> R: Right Hand wall fixing / L: Left Hand wall fixing **FXSBCRS - Across Support Bar**	1280 - 1290 mm	£1,364
FXSUZ120FLIPL.. FXSUZ120FLIPR..	Fixed Panel <b>1200 x 2100 mm with 300 Flipper.</b> R: Right Hand wall fixing / L: Left Hand wall fixing **FXSBCRS - Across Support Bar**	1480 - 1490 mm	£1,451
FXSUZ140FLIPL.. FXSUZ140FLIPR..	Fixed Panel <b>1400 x 2100 mm with 300 Flipper.</b> R: Right Hand wall fixing / L: Left Hand wall fixing **FXSBCRS - Across Support Bar**	1680 - 1690 mm	£1,576

Please NOTE Support bars are included on price as per Product descriptions.

For dimensions that do not fit our Standard range please email us at [sales@drenchshowers.co.uk](mailto:sales@drenchshowers.co.uk).

### MATTE Colours available

	BK	<b>Matt Black</b>	RAL 9005
	GG	<b>Graphite Grey</b>	RAL 7024
	GM	<b>Gun Metal</b>	RAL 8019
	BO	<b>Burnt Orange</b>	RAL 3022
	LY	<b>Lemon Yellow</b>	RAL 1012
	PP	<b>Pale Pink</b>	RAL 3015
	BL	<b>Blanc</b>	RAL 9002
	TT	<b>Total White</b>	RAL 9003
	MI	<b>Mint</b>	RAL 6019
	FO	<b>Forest</b>	RAL 6009
	CB	<b>Capri Blue</b>	RAL 5019
	GN	<b>Grey Navy</b>	RAL 5008

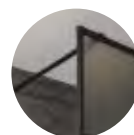

**FXSBCRS**  
Across Support Bar  
1000 mm



**FXSBNGL**  
Angle Support Bar  
450 mm

### Metalwork Design layout



### Glass Options available

Please NOTE other Glass options are available plus additional surcharge to prices listed above.

Plus 45% additional      Plus 35% additional

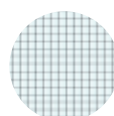

**Cross Fluted**  
8.8 mm TGH  
Laminated



**Fluted**  
8.8 mm TGH  
Laminated



**Frosted**  
8 mm TGH  
Satin Etch



**Grey Tinted**  
8 mm TGH  
Smoked glass

Any RAL Classic colours are available **plus 35% to prices above**. For both RAL and Glass Option together please add **65% to prices above**.

# SUZHOU MATTE Colours

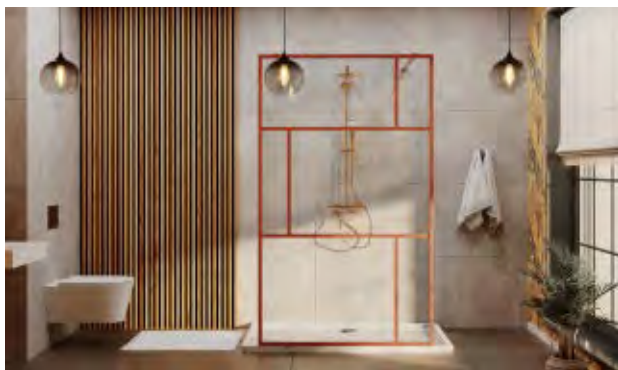
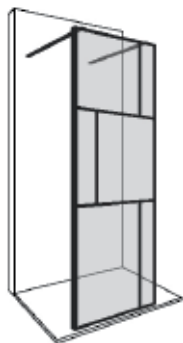

## Free Standing Panels

**Free standing Shower Screen** for Wet rooms and walk-in showers.  
2 Across Support bars included in price.

Please add the two letter colour code to your code chosen above.

Item Code	Description	Physical width of Unit	Retail Price Exc VAT (Clear Glass)
FXSUZ80FST..	Free Standing Panel <b>800 mm x 2100 mm</b> **2 x FXSBCRS - Across Support Bar**	762 mm	£1,030
FXSUZ90FST..	Free Standing Panel <b>900 mm x 2100 mm</b> **2 x FXSBCRS - Across Support Bar**	862 mm	£1,079
FXSUZ100FST..	Free Standing Panel <b>1000 mm x 2100 mm</b> **2 x FXSBCRS - Across Support Bar**	962 mm	£1,126
FXSUZ120FST..	Free Standing Panel <b>1200 mm x 2100 mm</b> **2 x FXSBCRS - Across Support Bar**	1162 mm	£1,223
FXSUZ140FST..	Free Standing Panel <b>1400 mm x 2100 mm</b> **2 x FXSBCRS - Across Support Bar**	1362 mm	£1,320

Please NOTE Support bars are included on price as per Product descriptions.  
For dimensions that do not fit our Standard range please contact us, we are experts on Bespoke and made to measure projects.  
Please email us at [sales@drenchshowers.co.uk](mailto:sales@drenchshowers.co.uk).

### MATTE Colours available

	BK	<b>Matt Black</b>	RAL 9005
	GG	<b>Graphite Grey</b>	RAL 7024
	GM	<b>Gun Metal</b>	RAL 8019
	BO	<b>Burnt Orange</b>	RAL 3022
	LY	<b>Lemon Yellow</b>	RAL 1012
	PP	<b>Pale Pink</b>	RAL 3015
	BL	<b>Blanc</b>	RAL 9002
	TT	<b>Total White</b>	RAL 9003
	MI	<b>Mint</b>	RAL 6019
	FO	<b>Forest</b>	RAL 6009
	CB	<b>Capri Blue</b>	RAL 5019
	GN	<b>Grey Navy</b>	RAL 5008

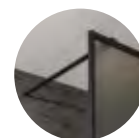

**FXSBCRS (x2)**  
Across Support Bar  
1000 mm

### Metalwork Design layout

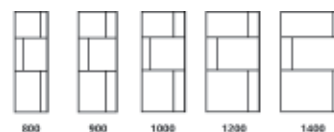

### Glass Options available

Please NOTE other Glass options are available plus additional surcharge to prices listed above.

Plus 45% additional

Plus 35% additional

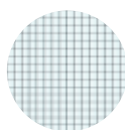

**Cross Fluted**  
8.8 mm TGH  
Laminated



**Fluted**  
8.8 mm TGH  
Laminated



**Frosted**  
8 mm TGH  
Satin Etch



**Grey Tinted**  
8 mm TGH  
Smoked glass

Any RAL Classic colours are available **plus 35% to prices above**. For both RAL and Glass Option together please add 65% to prices above.

# MATTE Colours





## Support Bars for Panel Combinations

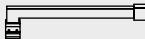

DRENCH Shower panels can be used individually or combined to recreate a walk-in shower space. When Shower panels are ordered individually support bars required for installation are included in the price and supplied by DRENCH.

When Shower Panels are combined, possibilities are endless hence we have designed a range of accessories suitable for any design or configuration.

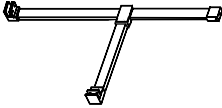
All support bars and fixings are supplied in same colour/finish as the Shower panel.

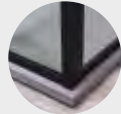
Item Code	Item Description	Specification	Retail Price Metallic Finishes (Exc VAT)
FXSBNGL..	<b>90° Angle Support Bar</b> (3 components, not pre-assembled) 450 mm length, 30 x 10 mm bar. **Not suitable for panels wider than 1000 mm**	 	£99
FXSBTBAR..	<b>T Shape Support bar</b> (4 components, not pre-assembled) 2x 30 x 10 mm bars. Long bar 1200 mm + Short bar at 1000 mm **Suitable for Shower Panels combinations**	 	£139
PR758..	<b>Corner Channel</b> for L Shape configurations Wall Fixings included. <b>2100 mm standard length</b>	 	£128

### Shower Panels Combinations Sample Layouts

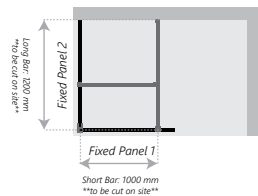
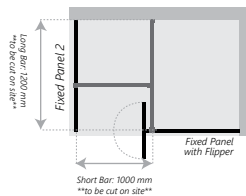
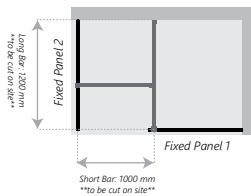

For Walk-In showers with Wall Fixed panels, **T Shape support bar (FXSBT-BAR..)** is recommended for installation purposes.

Please note the TBAR includes 2 bars at 1200 and 1000 mm. These bars can be trimmed on site to fit most of standard walk in shower dimensions.

For Walk-In showers with Wall Fixed panels and Fixed Panel with Flipper, **T Shape support bar (FXSBT-BAR..)** is recommended for installation purposes.

Please note the TBAR includes 2 bars at 1200 and 1000 mm. These bars can be trimmed on site to fit most of standard walk in shower dimensions.

For L-Shape configurations with Wall Fixed panels, **Corner channel (PR758)** and extra **T Shape support bar (FXSBT-BAR..)** is recommended for installation purposes.

Please note the TBAR includes 2 bars at 1200 and 1000 mm. These bars can be trimmed on site to fit most of standard walk in shower dimensions.



### Wall Fixed Panels

Panel is attached to the Wall using Wall Channel and Support Bar.

## Metallic Finishes





# SUZHOU Metallic Finishes

## Wall Fixed Panels

Please choose your codes depending on width required and add the two letter colour code to it.

Prices below are RRP exc VAT for CLEAR GLASS, other GLASS OPTIONS are available plus additional surcharge.



LH  
Left Hand







RH  
Right Hand

Item Code	Description	Adjustment Range	Retail Price Exc VAT (Clear Glass)
FXSUZ30L.. FXSUZ30R..	Fixed Panel <b>300 mm x 2100 mm.</b> L Left Hand Wall Fixed. R Right Hand Wall Fixed. <b>**No support Bar Included**</b>	275 - 290 mm	£1,111
FXSUZ40L.. FXSUZ40R..	Fixed Panel <b>400 mm x 2100 mm</b> L Left Hand Wall Fixed. R Right Hand Wall Fixed. <b>**No support Bar Included**</b>	375 - 390 mm	£1,198
FXSUZ50L.. FXSUZ50R..	Fixed Panel <b>500 mm x 2100 mm</b> L Left Hand Wall Fixed. R Right Hand Wall Fixed. <b>**FXSBCRS - Across Support Bar**</b>	475 - 490 mm	£1,164
FXSUZ60L.. FXSUZ60R..	Fixed Panel <b>600 mm x 2100 mm</b> L Left Hand Wall Fixed. R Right Hand Wall Fixed. <b>**FXSBCRS - Across Support Bar**</b>	575 - 590 mm	£1,288
FXSUZ70L.. FXSUZ70R..	Fixed Panel <b>700 mm x 2100 mm</b> L Left Hand Wall Fixed. R Right Hand Wall Fixed. <b>**FXSBCRS - Across Support Bar**</b>	675 - 690 mm	£1,378
FXSUZ80L.. FXSUZ80R..	Fixed Panel <b>800 mm x 2100 mm</b> L Left Hand Wall Fixed. R Right Hand Wall Fixed. <b>**FXSBCRS - Across Support Bar**</b>	775 - 790 mm	£1,449
FXSUZ90L.. FXSUZ90R..	Fixed Panel <b>900 mm x 2100 mm</b> L Left Hand Wall Fixed. R Right Hand Wall Fixed. <b>**FXSBCRS - Across Support Bar**</b>	875 - 890 mm	£1,520
FXSUZ100L.. FXSUZ100R..	Fixed Panel <b>1000 mm x 2100 mm</b> L Left Hand Wall Fixed. R Right Hand Wall Fixed. <b>**FXSBCRS - Across Support Bar**</b>	975 - 990 mm	£1,594
FXSUZ120L.. FXSUZ120R..	Fixed Panel <b>1200 mm x 2100 mm</b> L Left Hand Wall Fixed. R Right Hand Wall Fixed. <b>**FXSBCRS - Across Support Bar**</b>	1175 - 1190 mm	£1,741
FXSUZ140L.. FXSUZ140R..	Fixed Panel <b>1400 mm x 2100 mm</b> L Left Hand Wall Fixed. R Right Hand Wall Fixed. <b>**FXSBCRS - Across Support Bar**</b>	1375 - 1390 mm	£1,996

Please NOTE Support bars are included on price as per Product descriptions. For dimensions that do not fit our Standard range please contact us, we are experts on Bespoke and made to measure projects.

Please email us at [sales@drenchshowers.co.uk](mailto:sales@drenchshowers.co.uk).

### Metallic Finishes available

	LB	<b>Light Bronze</b>	Anodised
	DB	<b>Dark Bronze</b>	Anodised
	BS	<b>Brushed Steel</b>	Anodised
	BB	<b>Brushed Brass</b>	Anodised



**FXSBCRS**  
Across Support Bar  
1000 mm

### Metalwork Design layout

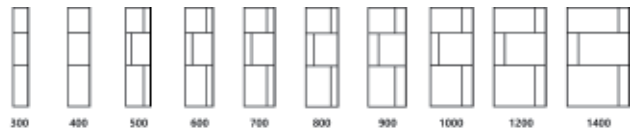

### Glass Options available

Please NOTE other Glass options are available plus additional surcharge to prices listed above.

Plus 45% additional

Plus 35% additional

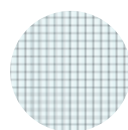

**Cross Fluted**  
8.8 mm TGH  
Laminated



**Fluted**  
8.8 mm TGH  
Laminated



**Frosted**  
8 mm TGH  
Satin Etch

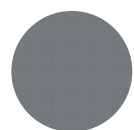

**Grey Tinted**  
8 mm TGH  
Smoked glass



## Fixed Panels with Flipper Panel

**Flipper panel is delivered already assembled to the fixed panel.**

It cannot be installed retrospectively.  
The pivot mechanism is adjustable from 0 de to 180 degree position.

## Metallic Finishes





# SUZHOU Metallic Finishes

## Fixed Panels with Flipper

Please choose your codes depending on width required and add the two letter colour code to it.  
**NOTE This item is Handed so Left or Right Hand need to be specified.**



**LH**  
Left Hand



**RH**  
Right Hand

Item Code	Description	Adjustment Range	Retail Price Exc VAT (Clear Glass)
FXSUZ30FLIPL.. FXSUZ30FLIPR..	Fixed Panel <b>300 x 2100 mm with 300 Flipper.</b> R: Right Hand wall fixing / L: Left Hand wall fixing **FXSBCRS - Across Support Bar**	580 - 590 mm	£1,416
FXSUZ40FLIPL.. FXSUZ40FLIPR..	Fixed Panel <b>400 x 2100 mm with 300 Flipper.</b> R: Right Hand wall fixing / L: Left Hand wall fixing **FXSBCRS - Across Support Bar**	680 - 690 mm	£1,491
FXSUZ50FLIPL.. FXSUZ50FLIPR..	Fixed Panel <b>500 x 2100 mm with 300 Flipper.</b> R: Right Hand wall fixing / L: Left Hand wall fixing **FXSBCRS - Across Support Bar**	780 - 790 mm	£1,529
FXSUZ60FLIPL.. FXSUZ60FLIPR..	Fixed Panel <b>600 x 2100 mm with 300 Flipper.</b> R: Right Hand wall fixing / L: Left Hand wall fixing **FXSBCRS - Across Support Bar**	880 - 890 mm	£1,553
FXSUZ70FLIPL.. FXSUZ70FLIPR..	Fixed Panel <b>700 x 2100 mm with 300 Flipper.</b> R: Right Hand wall fixing / L: Left Hand wall fixing **FXSBCRS - Across Support Bar**	980 - 990 mm	£1,623
FXSUZ80FLIPL.. FXSUZ80FLIPR..	Fixed Panel <b>800 x 2100 mm with 300 Flipper.</b> R: Right Hand wall fixing / L: Left Hand wall fixing **FXSBCRS - Across Support Bar**	1080 - 1090 mm	£1,853
FXSUZ90FLIPL.. FXSUZ90FLIPR..	Fixed Panel <b>900 x 2100 mm with 300 Flipper.</b> R: Right Hand wall fixing / L: Left Hand wall fixing **FXSBCRS - Across Support Bar**	1180 - 1190 mm	£1,922
FXSUZ100FLIPL.. FXSUZ100FLIPR..	Fixed Panel <b>1000 x 2100 mm with 300 Flipper.</b> R: Right Hand wall fixing / L: Left Hand wall fixing **FXSBCRS - Across Support Bar**	1280 - 1290 mm	£1,997
FXSUZ120FLIPL.. FXSUZ120FLIPR..	Fixed Panel <b>1200 x 2100 mm with 300 Flipper.</b> R: Right Hand wall fixing / L: Left Hand wall fixing **FXSBCRS - Across Support Bar**	1480 - 1490 mm	£2,146
FXSUZ140FLIPL.. FXSUZ140FLIPR..	Fixed Panel <b>1400 x 2100 mm with 300 Flipper.</b> R: Right Hand wall fixing / L: Left Hand wall fixing **FXSBCRS - Across Support Bar**	1680 - 1690 mm	£2,283

Please NOTE Support bars are included on price as per Product descriptions.  
 For dimensions that do not fit our Standard range please email us at [sales@drenchshowers.co.uk](mailto:sales@drenchshowers.co.uk).

### Metallic Finishes available

	LB	<b>Light Bronze</b>	Anodised
	DB	<b>Dark Bronze</b>	Anodised
	BS	<b>Brushed Steel</b>	Anodised
	BB	<b>Brushed Brass</b>	Anodised



**FXSBCRS**  
Across Support Bar  
1000 mm

### Metalwork Design layout

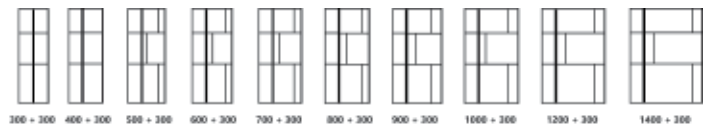

### Glass Options available

Please NOTE other Glass options are available plus additional surcharge to prices listed above.

Plus 45% additional

Plus 35% additional

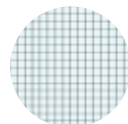

**Cross Fluted**

8.8 mm TGH  
Laminated



**Fluted**

8.8 mm TGH  
Laminated



**Frosted**

8 mm TGH  
Satin Etch

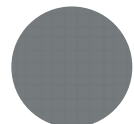

**Grey Tinted**

8 mm TGH  
Smoked glass

# SUZHOU Metallic Finishes



## Free Standing Panels





**Free standing Shower Screen** for Wet rooms and walk-in showers.  
2 Across Support bars included in price.

Please add the two letter colour code to your code chosen above.

Item Code	Description	Physical width of Unit	Retail Price Exc VAT (Clear Glass)
FXSUZ80FST..	Free Standing Panel <b>800 mm x 2100 mm</b> **2 x FXSBCRS - Across Support Bar**	762 mm	£1,449
FXSUZ90FST..	Free Standing Panel <b>900 mm x 2100 mm</b> **2 x FXSBCRS - Across Support Bar**	862 mm	£1,520
FXSUZ100FST..	Free Standing Panel <b>1000 mm x 2100 mm</b> **2 x FXSBCRS - Across Support Bar**	962 mm	£1,594
FXSUZ120FST..	Free Standing Panel <b>1200 mm x 2100 mm</b> **2 x FXSBCRS - Across Support Bar**	1162 mm	£1,741
FXSUZ140FST..	Free Standing Panel <b>1400 mm x 2100 mm</b> **2 x FXSBCRS - Across Support Bar**	1362 mm	£1,996

Please NOTE Support bars are included on price as per Product descriptions.  
For dimensions that do not fit our Standard range please contact us, we are experts on Bespoke and made to measure projects.  
Please email us at [sales@drenchshowers.co.uk](mailto:sales@drenchshowers.co.uk).

### Metallic Finishes available

	LB	<b>Light Bronze</b>	Anodised
	DB	<b>Dark Bronze</b>	Anodised
	BS	<b>Brushed Steel</b>	Anodised
	BB	<b>Brushed Brass</b>	Anodised



**FXSBCRS**  
Across Support Bar  
1000 mm

### Metalwork Design layout

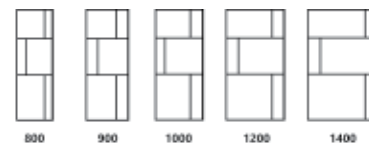

### Glass Options available

Please NOTE other Glass options are available plus additional surcharge to prices listed above.

Plus 45% additional

Plus 35% additional

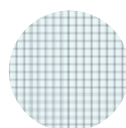

**Cross Fluted**  
8.8 mm TGH  
Laminated



**Fluted**  
8.8 mm TGH  
Laminated



**Frosted**  
8 mm TGH  
Satin Etch



**Grey Tinted**  
8 mm TGH  
Smoked glass







# Metallic Finishes

## Support Bars for Panel Combinations

DRENCH Shower panels can be used individually or combined to recreate a walk-in shower space. When Shower panels are ordered individually support bars required for installation are included in the price and supplied by DRENCH.

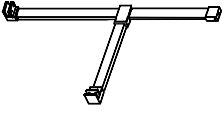
When Shower Panels are combined, possibilities are endless hence we have designed a range of accessories suitable for any design or configuration.

All support bars and fixings are supplied in same colour/finish as the Shower panel.

Item Code	Item Description	Specification	Retail Price Metallic Finishes (Exc VAT)
FXSBTBAR..	<b>T Shape Support bar</b> (4 components, not pre-assembled) 2x 30 x 10 mm bars. Long bar 1200 mm + Short bar at 1000 mm **Suitable for Shower Panels combinations**	 	£235
PR758..	<b>Corner Channel</b> for L Shape configurations Wall Fixings included. <b>2100 mm standard length</b>	 	£213

### Shower Panels Combinations Sample Layouts

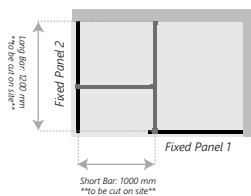

For Walk-In showers with Wall Fixed panels, **T Shape support bar (FXSBT-BAR..)** is recommended for installation purposes.

Please note the TBAR includes 2 bars at 1200 and 1000 mm.

These bars can be trimmed on site to fit most of standard walk in shower dimensions.

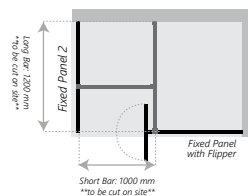

For Walk-In showers with Wall Fixed panels and Fixed Panel with Flipper, **T Shape support bar (FXSBT-BAR..)** is recommended for installation purposes.

Please note the TBAR includes 2 bars at 1200 and 1000 mm.

These bars can be trimmed on site to fit most of standard walk in shower dimensions.

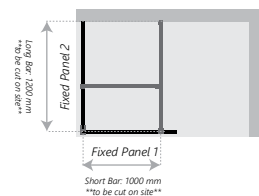

For L-Shape configurations with Wall Fixed panels, **Corner channel (PR758)** and extra **T Shape support bar (FXSBT-BAR..)** is recommended for installation purposes.

Please note the TBAR includes 2 bars at 1200 and 1000 mm.

These bars can be trimmed on site to fit most of standard walk in shower dimensions.



## Bath Screens



**SUZHOU**  
MATTE Colours

There is really nothing better than a nice long soak in the tub after a long and stressful day.

We love the idea we can contribute to make your bathtub look different with our range of Bath Screens.

DRENCH Bath Screens are available in pretty much all collections plus you can choose between 12 MATTE Colour options, 6 Metallic Finishes and our gorgeous glass options like Fluted, Frosted and Grey Tinted Glass.



**Fixed Bath Screen**  
Wall Fixed channel  
Included

**Fixed Bath screen** are a reduced version or our **Wall fixed** panels suitable to be installed onto a bath. This configuration ticks the box for small bathrooms.

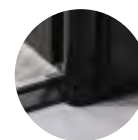

**Pivot hinged Bath Screen**

**Pivot Bath Screens** are hinged to the wall and swing **180 degrees**. Pivot bath screens are handed so make sure you choose the **Left or Right** hand code when ordering.

There is a 10 mm gap between the bottom profile and the top of the bath to allow the pivot mechanism work. A black rubber seal is supplied with the screen to cover the gap and guarantee watertight conditions.



# SUZHOU MATTE Colours

## Bath Screens

**Both pivot and fixed bath screen options available.**  
Please add the two letter colour code to your code chosen above.

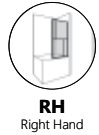
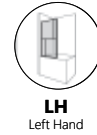

Item Code	Description	Adjustment Range	Retail Price Exc VAT (Clear Glass)
SUZFXBAT..	Fixed Bath Screen <b>800 x 1500 mm</b>	760 - 780 mm	£714
SUZBATL.. SUZBATR..	Pivot Hinged Bath Screen <b>800 x 1500 mm</b> L Left Hand / R Right Hand	760 - 780 mm	£770

For dimensions that do not fit our Standard range please contact us, we are experts on Bespoke and made to measure projects.  
Please email us at [sales@drenchshowers.co.uk](mailto:sales@drenchshowers.co.uk).

### MATTE Colours available

	BK	<b>Matt Black</b>	RAL9005
	GG	<b>Graphite Grey</b>	RAL7024
	GM	<b>Gun Metal</b>	RAL 8019
	BO	<b>Burnt Orange</b>	RAL 3022
	LY	<b>Lemon Yellow</b>	RAL 1012
	PP	<b>Pale Pink</b>	RAL 3015
	BL	<b>Blanc</b>	RAL 9002
	TT	<b>Total White</b>	RAL9003
	MI	<b>Mint</b>	RAL 6019
	FO	<b>Forest</b>	RAL 6009
	CB	<b>Capri Blue</b>	RAL 5019
	GN	<b>Grey Navy</b>	RAL 5008

### Metalwork Design layout



### Glass Options available

Please NOTE other Glass options are available plus additional surcharge to prices listed above.

Plus 45% additional

Plus 35% additional

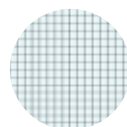

**Cross Fluted**  
8.8 mm TGH  
Laminated



**Fluted**  
8.8 mm TGH  
Laminated



**Frosted**  
8 mm TGH  
Satin Etch



**Grey Tinted**  
8 mm TGH  
Smoked glass

Any RAL Classic colours are available **plus 35% to prices above**. For both RAL and Glass Option together please add **65% to prices above**.



## Bath Screens



### SUZHOU Metallic Finishes

There is really nothing better than a nice long soak in the tub after a long and stressful day.

We love the idea we can contribute to make your bathtub look different with our range of Bath Screens.

DRENCH Bath Screens are available in pretty much all collections plus you can choose between 12 MATTE Colour options, 6 Metallic Finishes and our gorgeous glass options like Fluted, Frosted and Grey Tinted Glass.



**Fixed Bath Screen**  
Wall Fixed channel  
Included

**Fixed Bath screen** are a reduced version or our **Wall fixed** panels suitable to be installed onto a bath. This configuration ticks the box for small bathrooms.

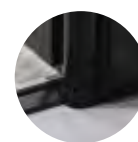

**Pivot Hinge  
Bath Screen**

**Pivot Bath Screens** are hinged to the wall and swing **180 degrees**. Pivot bath screens are handed so make sure you choose the **Left or Right** hand code when ordering.

There is a 10 mm gap between the bottom profile and the top of the bath to allow the pivot mechanism work. A black rubber seal is supplied with the screen to cover the gap and guarantee watertight conditions.



# SUZHOU Metallic Finishes

## Bath Screens

**Both pivot and fixed bath screen options available.**  
Please add the two letter colour code to your code chosen above.



**LH**  
Left Hand







**RH**  
Right Hand

Item Code	Description	Adjustment Range	Retail Price Exc VAT (Clear Glass)
<b>SUZFXBAT..</b>	Fixed Bath Screen <b>800 x 1500 mm</b>	760 - 780 mm	£954
<b>SUZBATL..</b> <b>SUZBATR..</b>	Pivot Hinged Bath Screen <b>800 x 1500 mm</b> L Left Hand / R Right Hand	760 - 780 mm	£1,035

For dimensions that do not fit our Standard range please contact us, we are experts on Bespoke and made to measure projects.  
Please email us at [sales@drenchshowers.co.uk](mailto:sales@drenchshowers.co.uk).

### Metallic Finishes available

	LB	<b>Light Bronze</b>	Anodised
	DB	<b>Dark Bronze</b>	Anodised
	BS	<b>Brushed Steel</b>	Anodised
	BB	<b>Brushed Brass</b>	Anodised

### Metalwork Design layout



### Glass Options available

Please NOTE other Glass options are available plus additional surcharge to prices listed above.

Plus 45% additional

Plus 35% additional

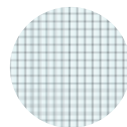

**Cross Fluted**  
8.8 mm TGH  
Laminated



**Fluted**  
8.8 mm TGH  
Laminated



**Frosted**  
8 mm TGH  
Satin Etch



**Grey Tinted**  
8 mm TGH  
Smoked glass

# Single Shower Doors



**SUZHOU**  
MATTE Colours

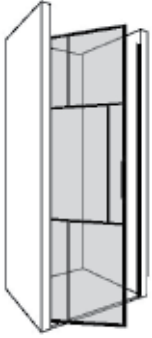

**LH**  
Left Hand

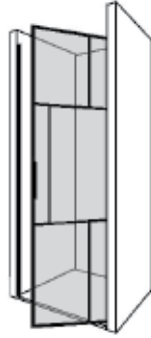

**RH**  
Right Hand

Single doors are suitable for shower recesses. **Left** or **Right** hand options are available.

Doors are built using our **pivot hinge**. The 5 mm rise and fall mechanism is manufactured using zinc die castings which give a durable and strong door performance. The **magnetic closing** creates a secure seal after the shower door is closed.

**Pull handle, fixings and door seal are included in the price below.**



Item Code	Description	Adjustment Range		Retail Price Exc VAT (Clear Glass)
		In a recess	With Return Panel	
SUZDOR70L.. SUZDOR70R..	Shower Door <b>700 x 2100 mm</b> , L Left Hand / R Right Hand	667 - 699 mm	675 - 690 mm	£1,016
SUZDOR76L.. SUZDOR76R..	Shower Door <b>760 x 2100 mm</b> , L Left Hand / R Right Hand	727 - 759 mm	735 - 750 mm	£1,047
SUZDOR80L.. SUZDOR80R..	Shower Door <b>800 x 2100 mm</b> , L Left Hand / R Right Hand	767 - 799 mm	775 - 790 mm	£1,254
SUZDOR90L.. SUZDOR90R..	Shower Door <b>900 x 2100 mm</b> , L Left Hand / R Right Hand	867 - 899 mm	875 - 890 mm	£1,291

Please choose your codes depending on width required and add the two letter colour code to it.

**NOTE This item is Handed so Left or Right Hand need to be specified.**

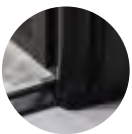

**Pivot hinge**

Our Pivot hinge system with a 5 mm rise and fall mechanism. **Pivot swing can be set from 0 to 180 degree position.**

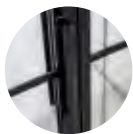

**PHAND**

Minimalistic pull handle. Mechanically fixed to Closing Post.

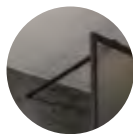

**FXSBCRS**

Across Support Bar 1000 mm

**\*\*When Door paired with Return Panel\*\***

**Metalwork Design layout**



700/760



800



900

# Return Panels for Shower Doors Enclosures

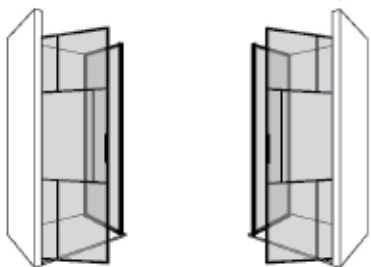

Shower doors may be paired with a range of Return/Side Panels to create Shower Cubicles. Return panels must be ordered with the door.  
If you want to create a Shower Enclosure please follow the steps below:

1. Choose your Door size, handing, colour and glass option and keep the code.
2. Choose the Return size check the hand required and keep the code. Our handing is based on the wall fixing position when you look at it from the outside.
3. Specify both codes on your order and DRENCH will make sure the correct Shower cubicle is delivered including wall fixings, handle and Support bars required.



Item Code	Description	Adjustment Range	Retail Price Exc VAT (Clear Glass)
+SUZ70L.. +SUZ70R..	Return Panel <b>700 x 2100 mm</b> L Left Hand / R Right Hand <i>**FXSBCRS - Across Support Bar**</i>	675 - 690 mm	£824
+SUZ80L.. +SUZ80R..	Return Panel <b>800 x 2100 mm</b> L Left Hand / R Right Hand <i>**FXSBCRS - Across Support Bar**</i>	775 - 780 mm	£860
+SUZ90L.. +SUZ90R..	Return Panel <b>900 x 2100 mm</b> L Left Hand / R Right Hand <i>**FXSBCRS - Across Support Bar**</i>	875 - 890 mm	£913
+SUZ100L.. +SUZ100R..	Return Panel <b>1000 x 2100 mm</b> L Left Hand / R Right Hand <i>**FXSBCRS - Across Support Bar**</i>	975 - 990 mm	£980

For dimensions that do not fit our Standard range please contact us, We are experts on Bespoke and made to measure projects. Please email us at [sales@drenchshowers.co.uk](mailto:sales@drenchshowers.co.uk).

## MATTE Colours available

	BK	<b>Matt Black</b>	RAL 9005
	GG	<b>Graphite Grey</b>	RAL 7024
	GM	<b>Gun Metal</b>	RAL 8019
	BO	<b>Burnt Orange</b>	RAL 3022
	LY	<b>Lemon Yellow</b>	RAL 1012
	PP	<b>Pale Pink</b>	RAL 3015
	BL	<b>Blanc</b>	RAL 9002
	TT	<b>Total White</b>	RAL 9003
	MI	<b>Mint</b>	RAL 6019
	FO	<b>Forest</b>	RAL 6009
	CB	<b>Capri Blue</b>	RAL 5019
	GN	<b>Grey Navy</b>	RAL 5008

Any RAL Classic colours are available **plus 35% to prices above**. For both RAL and Glass Option together please add **65% to prices above**.

## Metalwork Design layout

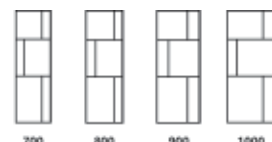

## Shower Door with Return Panel Configurations

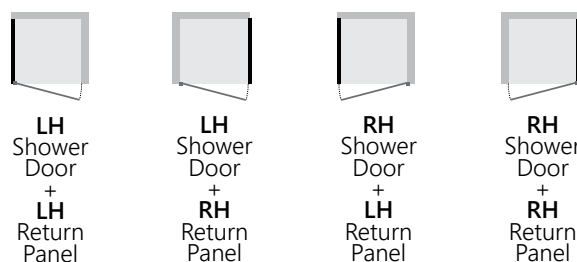

## Glass Options available

Please NOTE other Glass options are available plus additional surcharge to prices listed above.

Plus 45% additional		Plus 35% additional	
	<b>Cross Fluted</b> 8.8 mm TGH Laminated		<b>Fluted</b> 8.8 mm TGH Laminated
	<b>Frosted</b> 8 mm TGH Satin Etch		<b>Grey Tinted</b> 8 mm TGH Smoked glass

# Shower Door with Inline panel



**SUZHOU**  
MATTE Colours

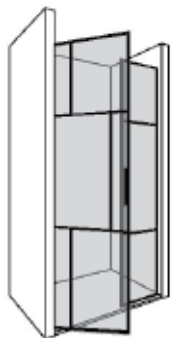

**LH**  
Left Hand

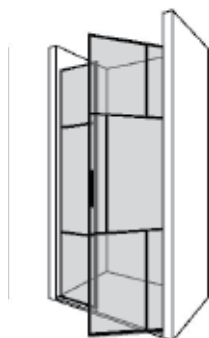

**RH**  
Right Hand

Door is hinged to the wall closing onto an Inline panel. Left or Right hand options are available.

Doors are built using our **pivot hinge**. The 5 mm rise and fall mechanism is manufactured using zinc die castings which give a durable and strong door performance. The **magnetic closing** creates a secure seal after the shower door is closed.

**Pull handle, fixings and door seal are included in the price below.**



Item Code	Description	Adjustment Range	Adjustment Range	Retail Price Exc VAT (Clear Glass)
		In a recess	With Return Panel	
SUZDI70/20L.. SUZDI70/20R..	Door with Inline <b>900 x 2100 mm</b> (700 mm Door + 200 mm Inline Panel) L Left Hand / R Right Hand <b>**FXSBPRL - Parallel Support Bar included **</b>	867 - 899 mm	875 - 890 mm	£1,393
SUZDI70/30L.. SUZDI70/30R..	Door with Inline <b>1000 x 2100 mm</b> (700 mm Door + 300 mm Inline Panel) L Left Hand / R Right Hand <b>**FXSBPRL - Parallel Support Bar included **</b>	967 - 999 mm	975 - 990 mm	£1,455
SUZDI90/30L.. SUZDI90/30R..	Door with Inline <b>1200 x 2100 mm</b> (900 mm Door + 300 mm Inline Panel) L Left Hand / R Right Hand <b>**FXSBPRL - Parallel Support Bar included **</b>	1167 - 1199 mm	1175 - 1190 mm	£1,622
SUZDI70/70L.. SUZDI70/70R..	Door with Inline <b>1400 x 2100 mm</b> (700 mm Door + 700 mm Inline Panel) L Left Hand / R Right Hand <b>**FXSBPRL - Parallel Support Bar included **</b>	1367 - 1399 mm	1375 - 1390 mm	£2,059
SUZDI90/60L.. SUZDI90/60R..	Door with Inline <b>1500 x 2100 mm</b> (900 mm Door + 600 mm Inline Panel) L Left Hand / R Right Hand <b>**FXSBPRL - Parallel Support Bar included **</b>	1467 - 1499 mm	1475 - 1490 mm	£2,126
SUZDI90/70L.. SUZDI90/70R..	Door with Inline <b>1600 x 2100 mm</b> (900 mm Door + 700 mm Inline Panel) L Left Hand / R Right Hand <b>**FXSBPRL - Parallel Support Bar included **</b>	1567 - 1599 mm	1575 - 1590 mm	£2,291

All of our shower doors are Opening OUT, please contact us if Opening INWARDS is required. Please choose your codes depending on width required and add the two letter colour code to it.

**NOTE This item is Handed so Left or Right Hand need to be specified.**

## Metalwork Design layout

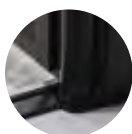

### Pivot hinge

Our Pivot hinge system with a 5 mm rise and fall mechanism. **Pivot swing can be set from 0 to 180 degree position.**



### PHAND

Minimalistic pull handle. Mechanically fixed to Closing Post.



### FXSBPRL

Parallel Support Bar 2000 mm  
(To be trimmed on site)

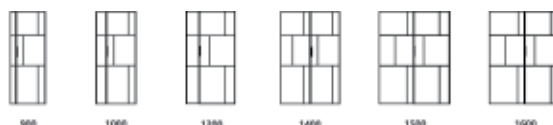

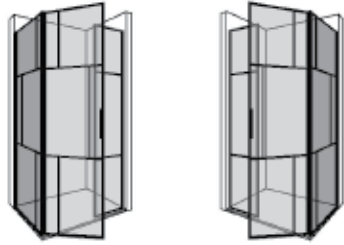

# Return Panels for Shower Door with Inline Enclosures



Shower doors with inline panel may be paired with a range of Return/Side Panels to create shower cubicles.

**Return panels must be ordered with the door.** If you want to create a Shower Enclosure please follow the steps below:

**1. Choose your Door with Inline size,** handing, colour and glass option and keep the code.

**2. Choose the Return size,** check the hand required and keep the code.

*\*\*Our handing is based on the wall fixing position when you look at it from the outside.\*\**

**3. Specify both codes** on your order and DRENCH will make sure the correct Shower cubicle is delivered including wall fixings, handle and Support bars required.

Item Code	Description	Adjustment Range	Retail Price Exc VAT (Clear Glass)
+SUZ70L.. +SUZ70R..	Return Panel <b>700 x 2100 mm</b> L Left Hand / R Right Hand <i>**FXSBDBL - Return Panel Support Bar**</i>	675 - 690 mm	£824
+SUZ80L.. +SUZ80R..	Return Panel <b>800 x 2100 mm</b> L Left Hand / R Right Hand <i>**FXSBDBL - Return Panel Support Bar**</i>	775 - 780 mm	£860
+SUZ90L.. +SUZ90R..	Return Panel <b>900 x 2100 mm</b> L Left Hand / R Right Hand <i>**FXSBDBL - Return Panel Support Bar**</i>	875 - 890 mm	£913
+SUZ100L.. +SUZ100R..	Return Panel <b>1000 x 2100 mm</b> L Left Hand / R Right Hand <i>**FXSBDBL - Return Panel Support Bar**</i>	975 - 990 mm	£980

*For dimensions that do not fit our Standard range please contact us, We are experts on Bespoke and made to measure projects. Please email us at [sales@drenchshowers.co.uk](mailto:sales@drenchshowers.co.uk).*

## MATTE Colours available

	BK	<b>Matt Black</b>	RAL 9005
	GG	<b>Graphite Grey</b>	RAL 7024
	GM	<b>Gun Metal</b>	RAL 8019
	BO	<b>Burnt Orange</b>	RAL 3022
	LY	<b>Lemon Yellow</b>	RAL 1012
	PP	<b>Pale Pink</b>	RAL 3015
	BL	<b>Blanc</b>	RAL 9002
	TT	<b>Total White</b>	RAL 9003
	MI	<b>Mint</b>	RAL 6019
	FO	<b>Forest</b>	RAL 6009
	CB	<b>Capri Blue</b>	RAL 5019
	GN	<b>Grey Navy</b>	RAL 5008



**FXSBDBL**  
Return panel Support Bar  
2000 mm

*\*\*Included\*\**

## Metalwork Design layout

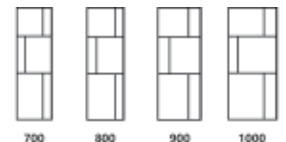

## Shower Door with Inline & Return Panel Configurations

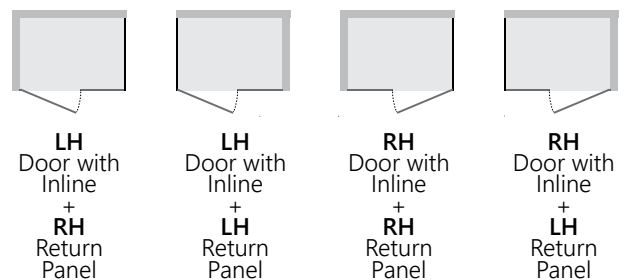

## Glass Options available

Please NOTE other Glass options are available plus additional surcharge to prices listed above.

Plus 45% additional		Plus 35% additional	
	<b>Cross Fluted</b> 8.8 mm TGH Laminated		<b>Fluted</b> 8.8 mm TGH Laminated
	<b>Frosted</b> 8 mm TGH Satin Etch		<b>Grey Tinted</b> 8 mm TGH Smoked glass

*Any RAL Classic colours are available plus 35% to prices above. For both RAL and Glass Option together please add 65% to prices above.*

# Shower Door hinged to Inline panel



**SUZHOU**  
MATTE Colours

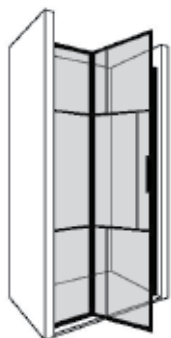

**LH**  
Left Hand

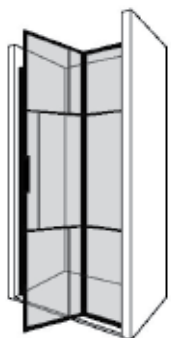

**RH**  
Right Hand

Shower Door is hinged to the Inline panel closing onto the wall. Left or Right hand options are available.

Doors are built using our **pivot hinge**. The 5 mm rise and fall mechanism is manufactured using zinc die castings which give a durable and strong door performance. The **magnetic closing** creates a secure seal after the shower door is closed.

**Pull handle, fixings and sealing components are included in prices below.**



Item Code	Description	Adjustment Range	Adjustment Range	Retail Price Exc VAT (Clear Glass)
		In a recess	With Return Panel	
SUZDH70/20L.. SUZDH70/20R..	Door hinged to Inline <b>900 x 2100 mm</b> (700 mm Door + 200 mm Inline Panel) L Left Hand / R Right Hand <i>**FXSBPRL - Parallel Support Bar included **</i>	869 - 899 mm	875 - 890 mm	£1,393
SUZDH70/30L.. SUZDH70/30R..	Door hinged to Inline <b>1000 x 2100 mm</b> (700 mm Door + 300 mm Inline Panel) L Left Hand / R Right Hand <i>**FXSBPRL - Parallel Support Bar included **</i>	969 - 999 mm	975 - 990 mm	£1,455
SUZDH90/30L.. SUZDH90/30R..	Door hinged to Inline <b>1200 x 2100 mm</b> (900 mm Door + 300 mm Inline Panel) L Left Hand / R Right Hand <i>**FXSBPRL - Parallel Support Bar included **</i>	1169 - 1199 mm	1175 - 1190 mm	£1,622
SUZDH70/70L.. SUZDH70/70R..	Door hinged to Inline <b>1400 x 2100 mm</b> (700 mm Door + 700 mm Inline Panel) L Left Hand / R Right Hand <i>**FXSBPRL - Parallel Support Bar included **</i>	1369 - 1399 mm	1375 - 1390 mm	£2,059
SUZDH90/60L.. SUZDH90/60R..	Door hinged to Inline <b>1500 x 2100 mm</b> (900 mm Door + 600 mm Inline Panel) L Left Hand / R Right Hand <i>**FXSBPRL - Parallel Support Bar included **</i>	1469 - 1499 mm	1475 - 1490 mm	£2,126
SUZDH90/70L.. SUZDH90/70R..	Door hinged to Inline <b>1600 x 2100 mm</b> (900 mm Door + 700 mm Inline Panel) L Left Hand / R Right Hand <i>**FXSBPRL - Parallel Support Bar included **</i>	1569 - 1599 mm	1575 - 1590 mm	£2,291

All of our shower doors are Opening OUT, please contact us if Opening INWARDS is required. Please choose your codes depending on width required and add the two letter colour code to it.

**NOTE This item is Handed so Left or Right Hand need to be specified.**

## Metalwork Design layout

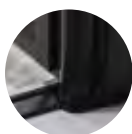

### Pivot hinge

Our Pivot hinge system with a 5 mm rise and fall mechanism. **Pivot swing can be set from 0 to 180 degree position.**

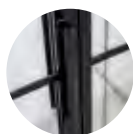

### PHAND

Minimalistic pull handle. Mechanically fixed to Closing Post.



### FXSBPRL

Parallel Support Bar 2000 mm (To be trimmed on site)

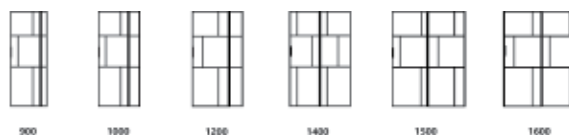

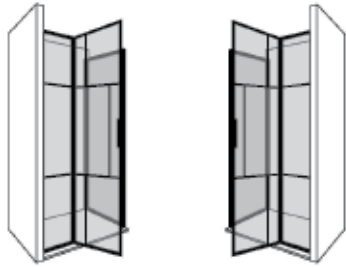

# Return Panels for Shower Door hinged to Inline Enclosures



Shower doors hinged to inline panel may be paired with a range of Return/Side Panels to create shower cubicles. **Return panels must be ordered with the door.** If you want to create a Shower Enclosure please follow the steps below:

- 1. Choose your Door hinged to Inline size,** handing, colour and glass option and keep the code.
- 2. Choose the Return size,** check the hand required and keep the code.  
*\*\*Our handing is based on the wall fixing position when you look at it from the outside.\*\**
- 3. Specify both codes** on your order and DRENCH will make sure the correct Shower cubicle is delivered including wall fixings, handle and Support bars required.

Item Code	Description	Adjustment Range	Retail Price Exc VAT (Clear Glass)
+SUZ70L.. +SUZ70R..	Return Panel <b>700 x 2100 mm</b> L Left Hand / R Right Hand <i>**FXSBDBL - Return Panel Support Bar**</i>	675 - 690 mm	£824
+SUZ80L.. +SUZ80R..	Return Panel <b>800 x 2100 mm</b> L Left Hand / R Right Hand <i>**FXSBDBL - Return Panel Support Bar**</i>	775 - 780 mm	£860
+SUZ90L.. +SUZ90R..	Return Panel <b>900 x 2100 mm</b> L Left Hand / R Right Hand <i>**FXSBDBL - Return Panel Support Bar**</i>	875 - 890 mm	£913
+SUZ100L.. +SUZ100R..	Return Panel <b>1000 x 2100 mm</b> L Left Hand / R Right Hand <i>**FXSBDBL - Return Panel Support Bar**</i>	975 - 990 mm	£980

For dimensions that do not fit our Standard range please contact us, We are experts on Bespoke and made to measure projects. Please email us at [sales@drenchshowers.co.uk](mailto:sales@drenchshowers.co.uk).



**FXSBDBL**  
Return panel Support Bar  
2000 mm

*\*\*Included\*\**

## Metalwork Design layout

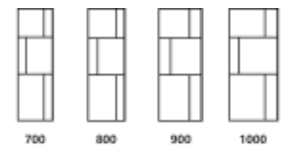

## Shower Door with Inline & Return Panel Configurations

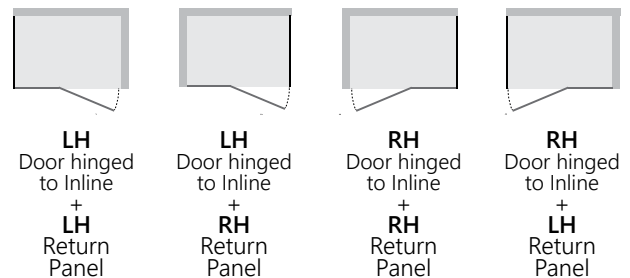

## Glass Options available

Please NOTE other Glass options are available plus additional surcharge to prices listed above.

Plus 45% additional		Plus 35% additional	
	<b>Cross Fluted</b> 8.8 mm TGH Laminated		<b>Fluted</b> 8.8 mm TGH Laminated
	<b>Frosted</b> 8 mm TGH Satin Etch		<b>Grey Tinted</b> 8 mm TGH Smoked glass

## MATTE Colours available

	BK	<b>Matt Black</b>	RAL 9005
	GG	<b>Graphite Grey</b>	RAL 7024
	GM	<b>Gun Metal</b>	RAL 8019
	BO	<b>Burnt Orange</b>	RAL 3022
	LY	<b>Lemon Yellow</b>	RAL 1012
	PP	<b>Pale Pink</b>	RAL 3015
	BL	<b>Blanc</b>	RAL 9002
	TT	<b>Total White</b>	RAL 9003
	MI	<b>Mint</b>	RAL 6019
	FO	<b>Forest</b>	RAL 6009
	CB	<b>Capri Blue</b>	RAL 5019
	GN	<b>Grey Navy</b>	RAL 5008

Any RAL Classic colours are available **plus 35% to prices above.** For both RAL and Glass Option together please add 65% to prices above.

# Single Shower Doors



## SUZHOU Metallic Finishes



**LH**  
Left Hand



**RH**  
Right Hand

Single doors are suitable for shower recesses. **Left** or **Right** hand options are available.

Doors are built using our **vintage butt hinges**. Each door includes 4 hinges equally positioned and recessed on profiles. The **magnetic closing** creates a secure seal after the shower door is closed.

**Pull handle, fixings and door seal are included in the price below.**



Item Code	Description	Adjustment Range		Retail Price Exc VAT (Clear Glass)
		In a recess	With Return Panel	
SUZDOR70L.. SUZDOR70R..	Shower Door <b>700 x 2100 mm</b> , L Left Hand / R Right Hand	671 - 689 mm	681 - 690 mm	£1,574
SUZDOR76L.. SUZDOR76R..	Shower Door <b>760 x 2100 mm</b> , L Left Hand / R Right Hand	721 - 739 mm	739 - 747 mm	£1,619
SUZDOR80L.. SUZDOR80R..	Shower Door <b>800 x 2100 mm</b> , L Left Hand / R Right Hand	771 - 789 mm	781 - 790 mm	£1,649
SUZDOR90L.. SUZDOR90R..	Shower Door <b>900 x 2100 mm</b> , L Left Hand / R Right Hand	871 - 889 mm	881 - 890 mm	£1,723

Please choose your codes depending on width required and add the two letter colour code to it.

**NOTE This item is Handed so Left or Right Hand need to be specified.**



### Butt Hinge

Vintage butt hinges. Each door included 4 hinges equally positioned and recessed on profiles.



### SPHAND

Shaped pull handle. Mechanically fixed to Closing Post.



### FXSBCRS

Across Support Bar 1000 mm

**\*\*When Door paired with Return Panel\*\***

### Metalwork Design layout



700/760



800



900



# Return Panels for Shower Doors Enclosures



Shower doors may be paired with a range of Return/Side Panels to create Shower Cubicles. Return panels must be ordered with the door.  
If you want to create a Shower Enclosure please follow the steps below:

1. Choose your Door size, handing, colour and glass option and keep the code.
2. Choose the Return size check the hand required and keep the code. Our handing is based on the wall fixing position when you look at it from the outside.
3. Specify both codes on your order and DRENCH will make sure the correct Shower cubicle is delivered including wall fixings, handle and Support bars required.

Item Code	Description	Adjustment Range	Retail Price Exc VAT (Clear Glass)
+SUZ70L.. +SUZ70R..	Return Panel <b>700 x 2100 mm</b> L Left Hand / R Right Hand <i>**FXSBCRS - Across Support Bar**</i>	675 - 690 mm	£1,067
+SUZ80L.. +SUZ80R..	Return Panel <b>800 x 2100 mm</b> L Left Hand / R Right Hand <i>**FXSBCRS - Across Support Bar**</i>	775 - 780 mm	£1,113
+SUZ90L.. +SUZ90R..	Return Panel <b>900 x 2100 mm</b> L Left Hand / R Right Hand <i>**FXSBCRS - Across Support Bar**</i>	875 - 890 mm	£1,159
+SUZ100L.. +SUZ100R..	Return Panel <b>1000 x 2100 mm</b> L Left Hand / R Right Hand <i>**FXSBCRS - Across Support Bar**</i>	975 - 990 mm	£1,236

For dimensions that do not fit our Standard range please contact us, We are experts on Bespoke and made to measure projects. Please email us at [sales@drenchshowers.co.uk](mailto:sales@drenchshowers.co.uk).

### Metallic Finishes available

	LB	<b>Light Bronze</b>	Anodised
	DB	<b>Dark Bronze</b>	Anodised
	BS	<b>Brushed Steel</b>	Anodised
	BB	<b>Brushed Brass</b>	Anodised

### Metalwork Design layout



### Shower Door with Return Panel Configurations

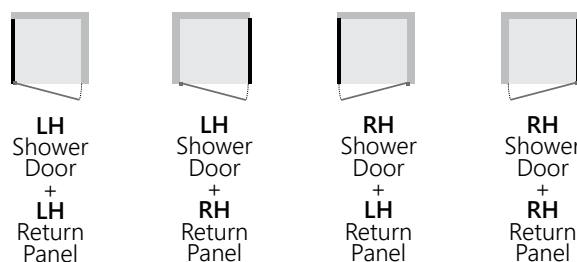

### Glass Options available

Please NOTE other Glass options are available plus additional surcharge to prices listed above.

Plus 45% additional		Plus 35% additional	
	<b>Cross Fluted</b> 8.8 mm TGH Laminated		<b>Fluted</b> 8.8 mm TGH Laminated
	<b>Frosted</b> 8 mm TGH Satin Etch		<b>Grey Tinted</b> 8 mm TGH Smoked glass

# Shower Door with Inline panel



**SUZHOU**  
Metallic Finishes



**LH**  
Left Hand

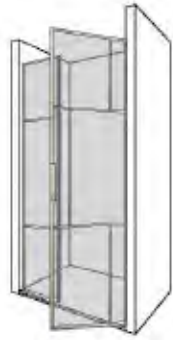

**RH**  
Right Hand

Door is hinged to the wall closing onto an Inline panel. Left or Right hand options are available.

Doors are built using 4 vintage ball bearing hinges finished in the metal chosen. The magnetic closing creates a secure seal after the shower door is closed.

Pull handle, fixings and door seal are included in the price below.



Item Code	Description	Adjustment Range	Adjustment Range	Retail Price Exc VAT (Clear Glass)
		In a recess	With Return Panel	
SUZDI70/20L.. SUZDI70/20R..	Door with Inline <b>900 x 2100 mm</b> (700 mm Door + 200 mm Inline Panel) L Left Hand / R Right Hand <i>**FXSBPRL - Parallel Support Bar included **</i>	871 - 889 mm	881 - 890 mm	£2,226
SUZDI70/30L.. SUZDI70/30R..	Door with Inline <b>1000 x 2100 mm</b> (700 mm Door + 300 mm Inline Panel) L Left Hand / R Right Hand <i>**FXSBPRL - Parallel Support Bar included **</i>	971 - 989 mm	981 - 990 mm	£2,305
SUZDI90/30L.. SUZDI90/30R..	Door with Inline <b>1200 x 2100 mm</b> (900 mm Door + 300 mm Inline Panel) L Left Hand / R Right Hand <i>**FXSBPRL - Parallel Support Bar included **</i>	1171 - 1189 mm	1181 - 1190 mm	£2,465
SUZDI70/70L.. SUZDI70/70R..	Door with Inline <b>1400 x 2100 mm</b> (700 mm Door + 700 mm Inline Panel) L Left Hand / R Right Hand <i>**FXSBPRL - Parallel Support Bar included **</i>	1371 - 1389 mm	1381 - 1390 mm	£2,625
SUZDI90/60L.. SUZDI90/60R..	Door with Inline <b>1500 x 2100 mm</b> (900 mm Door + 600 mm Inline Panel) L Left Hand / R Right Hand <i>**FXSBPRL - Parallel Support Bar included **</i>	1471 - 1489 mm	1481 - 1490 mm	£2,701
SUZDI90/70L.. SUZDI90/70R..	Door with Inline <b>1600 x 2100 mm</b> (900 mm Door + 700 mm Inline Panel) L Left Hand / R Right Hand <i>**FXSBPRL - Parallel Support Bar included **</i>	1571 - 1589 mm	1581 - 1590 mm	£2,770

All of our shower doors are Opening OUT, please contact us if Opening INWARDS is required.  
Please choose your codes depending on width required and add the two letter colour code to it.  
**NOTE This item is Handed so Left or Right Hand need to be specified.**

## Metalwork Design layout



**Butt Hinge**

Vintage butt hinges. Each door included 4 hinges equally positioned and recessed on profiles.



**SPHAND**

Shaped pull handle. Mechanically fixed to Closing Post.



**FXSBPRL**

Parallel Support Bar 2000 mm  
(To be trimmed on site)



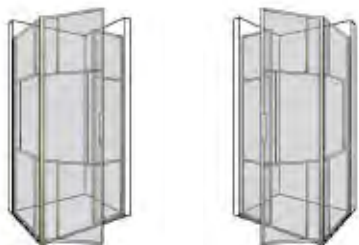

# Return Panels for Shower Door with Inline Enclosures



Shower doors with inline panel may be paired with a range of Return/Side Panels to create shower cubicles. **Return panels must be ordered with the door.** If you want to create a Shower Enclosure please follow the steps below:

**1. Choose your Door with Inline size,** handing, colour and glass option and keep the code.

**2. Choose the Return size,** check the hand required and keep the code.

*\*\*Our handing is based on the wall fixing position when you look at it from the outside.\*\**

**3. Specify both codes** on your order and DRENCH will make sure the correct Shower cubicle is delivered including wall fixings, handle and Support bars required.

Item Code	Description	Adjustment Range	Retail Price Exc VAT (Clear Glass)
+SUZ70L.. +SUZ70R..	Return Panel <b>700 x 2100 mm</b> L Left Hand / R Right Hand <i>**FXSBDBL - Return Panel Support Bar**</i>	675 - 690 mm	£1,067
+SUZ80L.. +SUZ80R..	Return Panel <b>800 x 2100 mm</b> L Left Hand / R Right Hand <i>**FXSBDBL - Return Panel Support Bar**</i>	775 - 780 mm	£1,113
+SUZ90L.. +SUZ90R..	Return Panel <b>900 x 2100 mm</b> L Left Hand / R Right Hand <i>**FXSBDBL - Return Panel Support Bar**</i>	875 - 890 mm	£1,159
+SUZ100L.. +SUZ100R..	Return Panel <b>1000 x 2100 mm</b> L Left Hand / R Right Hand <i>**FXSBDBL - Return Panel Support Bar**</i>	975 - 990 mm	£1,236

*For dimensions that do not fit our Standard range please contact us, We are experts on Bespoke and made to measure projects. Please email us at [sales@drenchshowers.co.uk](mailto:sales@drenchshowers.co.uk).*

### Metallic Finishes available

	LB	<b>Light Bronze</b>	Anodised
	DB	<b>Dark Bronze</b>	Anodised
	BS	<b>Brushed Steel</b>	Anodised
	BB	<b>Brushed Brass</b>	Anodised



**FXSBDBL**  
Return panel Support Bar  
2000 mm

*\*\*Included\*\**

### Metalwork Design layout

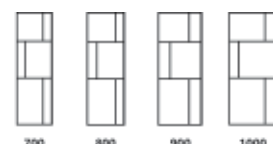

### Shower Door with Inline & Return Panel Configurations

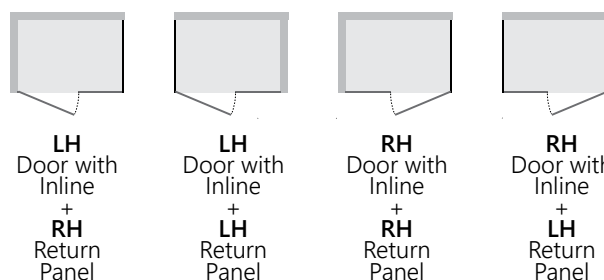

### Glass Options available

Please NOTE other Glass options are available plus additional surcharge to prices listed above.

Plus 45% additional	Plus 35% additional
---------------------	---------------------

<b>Cross Fluted</b> 8.8 mm TGH Laminated	<b>Fluted</b> 8.8 mm TGH Laminated	<b>Frosted</b> 8 mm TGH Satin Etch	<b>Grey Tinted</b> 8 mm TGH Smoked glass

*Any RAL Classic colours are available plus 35% to prices above. For both RAL and Glass Option together please add 65% to prices above.*

# Shower Door hinged to Inline panel



**SUZHOU**  
Metallic Finishes



**LH**  
Left Hand



**RH**  
Right Hand

Shower Door is hinged to the Inline panel closing onto the wall. Left or Right hand options are available.

Doors are built using 4 **vintage ball bearing hinges** finished in the metal chosen. The **magnetic closing** creates a secure seal after the shower door is closed.

**Pull handle, fixings and door seal are included in the price below.**



Item Code	Description	Adjustment Range	Adjustment Range	Retail Price Exc VAT (Clear Glass)
		In a recess	With Return Panel	
SUZDH70/20L... SUZDH70/20R...	Door hinged to Inline <b>900 x 2100 mm</b> (700 mm Door + 200 mm Inline Panel) L Left Hand / R Right Hand <b>**FXSBPRL - Parallel Support Bar included**</b>	871 - 889 mm	875 - 890 mm	£2,226
SUZDH70/30L... SUZDH70/30R...	Door hinged to Inline <b>1000 x 2100 mm</b> (700 mm Door + 300 mm Inline Panel) L Left Hand / R Right Hand <b>**FXSBPRL - Parallel Support Bar included**</b>	971 - 989 mm	975 - 990 mm	£2,305
SUZDH90/30L... SUZDH90/30R...	Door hinged to Inline <b>1200 x 2100 mm</b> (900 mm Door + 300 mm Inline Panel) L Left Hand / R Right Hand <b>**FXSBPRL - Parallel Support Bar included**</b>	1171 - 1189 mm	1175 - 1190 mm	£2,465
SUZDH70/70L... SUZDH70/70R...	Door hinged to Inline <b>1400 x 2100 mm</b> (700 mm Door + 700 mm Inline Panel) L Left Hand / R Right Hand <b>**FXSBPRL - Parallel Support Bar included**</b>	1371 - 1389 mm	1375 - 1390 mm	£2,625
SUZDH90/60L... SUZDH90/60R...	Door hinged to Inline <b>1500 x 2100 mm</b> (900 mm Door + 600 mm Inline Panel) L Left Hand / R Right Hand <b>**FXSBPRL - Parallel Support Bar included**</b>	1471 - 1489 mm	1475 - 1490 mm	£2,701
SUZDH90/70L... SUZDH90/70R...	Door hinged to Inline <b>1600 x 2100 mm</b> (900 mm Door + 700 mm Inline Panel) L Left Hand / R Right Hand <b>**FXSBPRL - Parallel Support Bar included**</b>	1571 - 1589 mm	1575 - 1590 mm	£2,770

All of our shower doors are Opening OUT, please contact us if Opening INWARDS is required. Please choose your codes depending on width required and add the two letter colour code to it.

**NOTE This item is Handed so Left or Right Hand need to be specified.**

## Metalwork Design layout



**Butt Hinge**

Vintage butt hinges. Each door included 4 hinges equally positioned and recessed on profiles.



**SPHAND**

Shaped pull handle. Mechanically fixed to Closing Post.



**FXSBPRL**

Parallel Support Bar 2000 mm (To be trimmed on site)



900



1000



1200



1400



1500



1600

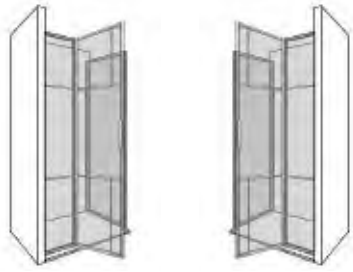

# Return Panels for Shower Door hinged to Inline Enclosures



Shower doors hinged to inline panel may be paired with a range of Return/Side Panels to create shower cubicles. **Return panels must be ordered with the door.** If you want to create a Shower Enclosure please follow the steps below:

- 1. Choose your Door hinged to Inline size,** handing, colour and glass option and keep the code.
- 2. Choose the Return size,** check the hand required and keep the code.  
*\*\*Our handing is based on the wall fixing position when you look at it from the outside.\*\**
- 3. Specify both codes** on your order and DRENCH will make sure the correct Shower cubicle is delivered including wall fixings, handle and Support bars required.

Item Code	Description	Adjustment Range	Retail Price Exc VAT (Clear Glass)
+SUZ70L.. +SUZ70R..	Return Panel <b>700 x 2100 mm</b> L Left Hand / R Right Hand <i>**FXSDBL - Return Panel Support Bar**</i>	675 - 690 mm	£1,067
+SUZ80L.. +SUZ80R..	Return Panel <b>800 x 2100 mm</b> L Left Hand / R Right Hand <i>**FXSDBL - Return Panel Support Bar**</i>	775 - 780 mm	£1,113
+SUZ90L.. +SUZ90R..	Return Panel <b>900 x 2100 mm</b> L Left Hand / R Right Hand <i>**FXSDBL - Return Panel Support Bar**</i>	875 - 890 mm	£1,159
+SUZ100L.. +SUZ100R..	Return Panel <b>1000 x 2100 mm</b> L Left Hand / R Right Hand <i>**FXSDBL - Return Panel Support Bar**</i>	975 - 990 mm	£1,236

For dimensions that do not fit our Standard range please contact us, We are experts on Bespoke and made to measure projects. Please email us at [sales@drenchshowers.co.uk](mailto:sales@drenchshowers.co.uk).

## Metallic Finishes available

	LB	<b>Light Bronze</b>	Anodised
	DB	<b>Dark Bronze</b>	Anodised
	BS	<b>Brushed Steel</b>	Anodised
	BB	<b>Brushed Brass</b>	Anodised



**FXSDBL**  
Return panel Support Bar  
2000 mm

*\*\*Included\*\**

## Metalwork Design layout

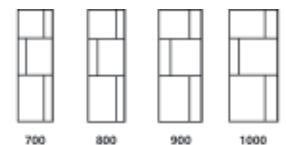

## Shower Door with Inline & Return Panel Configurations

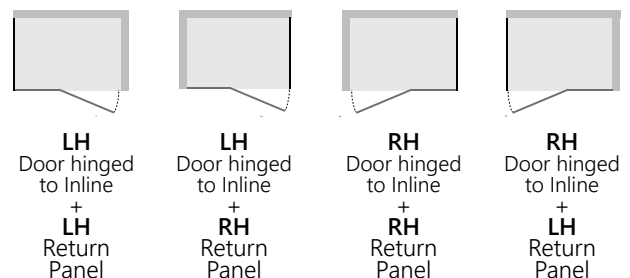

## Glass Options available

Please NOTE other Glass options are available plus additional surcharge to prices listed above.

Plus 45% additional		Plus 35% additional	
	<b>Cross Fluted</b> 8.8 mm TGH Laminated		<b>Fluted</b> 8.8 mm TGH Laminated
	<b>Frosted</b> 8 mm TGH Satin Etch		<b>Grey Tinted</b> 8 mm TGH Smoked glass

Any RAL Classic colours are available **plus 35% to prices above.** For both RAL and Glass Option together please add 65% to prices above.



*Single Shower Door 900 x 2100 mm Dark Bronze, Cross Fluted Glass*



**DECO**  
Collection





## DECO Collection

### FEATURES:

*ALL Product configurations*

*2100 mm Height*

*19 mm of Adjustment*

*12 MATTE Colours & 4 Metallic Finishes*

*8 mm Toughened Glass*

*(Fluted, Frosted, Grey Tinted & Clear Glass options)*

*Easy Clean Coating*

DECO Collection focuses on a horizontal look, giving the effect of a wider panel. Lines applied horizontally often evoke feelings of stability, grounding, emphasis and direction.

DECO style offers a sense of tranquility to your shower and fills the space harmoniously.

DECO collection is available for all DRENCH ranges including Panels, Bath Screens, Shower Doors & Shower Enclosures.

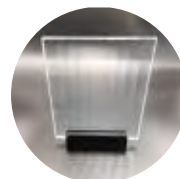
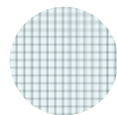

**Cross Fluted**

8.8 mm THG Laminated

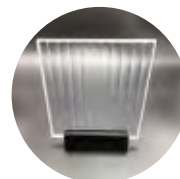

**Fluted**

8.8 mm THG Laminated

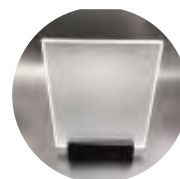

**Frosted**

8 mm THG Satin Etch

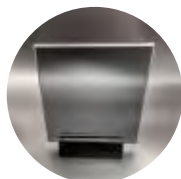

**Grey Tinted**



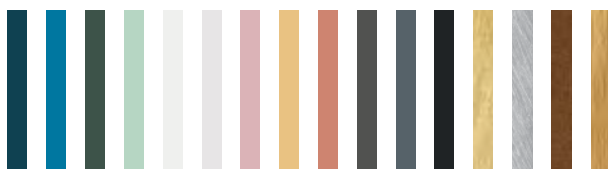





8 mm THG Smoked glass



**Product Configurations Available**



**Standard Dimensions Vs Product Configuration**

	300	400	500	600	700	800	900	1000	1200	1400	1500	1600
 <b>Wall Fixed Panels</b> Standard Height 2100 mm											✗	✗
 <b>Wall Fixed Panels with Flipper Panel</b> Standard Height 2100 mm											✗	✗
 <b>Free Standing Panels</b> Standard Height 2100 mm	✗	✗	✗	✗	✗						✗	✗
 <b>Single Shower Doors</b> Standard Height 2100 mm	✗	✗	✗	✗				✗	✗	✗	✗	✗
 <b>Shower Doors with Inline Panel</b> Standard Height 2100 mm	✗	✗	✗	✗	✗	✗						
 <b>Shower Doors hinged to Inline Panel</b> Standard Height 2100 mm	✗	✗	✗	✗	✗	✗						
 <b>Return Panels for Shower Enclosures</b> Standard Height 2100 mm	✗	✗	✗	✗					✗	✗	✗	✗
 <b>Bath Screens (Pivot &amp; Fixed)</b> Standard Height 1500 mm	✗	✗	✗	✗	✗		✗	✗	✗	✗	✗	✗





### Wall Fixed Panels

Panel is attached to the Wall using Wall Channel and Support Bar.

# MATTE Colours



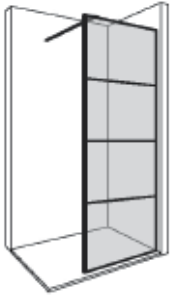

# DECO MATTE Colours

## Wall Fixed Panels

Please choose your codes depending on width required and add the two letter colour code to it. Prices below are RRP exc VAT for CLEAR GLASS, other GLASS OPTIONS are available plus additional surcharge.

Item Code	Description	Adjustment Range	Retail Price Exc VAT (Clear Glass)
FXDEC30..	Fixed Panel <b>300 mm x 2100 mm</b> <i>**No support Bar Included**</i>	275 - 290 mm	£626
FXDEC40..	Fixed Panel <b>400 mm x 2100 mm</b> <i>**No support Bar Included**</i>	375 - 390 mm	£668
FXDEC50..	Fixed Panel <b>500 mm x 2100 mm</b> <i>**FXSBNGL - Angle Support Bar**</i>	475 - 490 mm	£710
FXDEC60..	Fixed Panel <b>600 mm x 2100 mm</b> <i>**FXSBNGL - Angle Support Bar**</i>	575 - 590 mm	£754
FXDEC70..	Fixed Panel <b>700 mm x 2100 mm</b> <i>**FXSBNGL - Angle Support Bar**</i>	675 - 690 mm	£796
FXDEC80..	Fixed Panel <b>800 mm x 2100 mm</b> <i>**FXSBCRS - Across Support Bar**</i>	775 - 790 mm	£1,081
FXDEC90..	Fixed Panel <b>900 mm x 2100 mm</b> <i>**FXSBCRS - Across Support Bar**</i>	875 - 890 mm	£1,131
FXDEC100..	Fixed Panel <b>1000 mm x 2100 mm</b> <i>**FXSBCRS - Across Support Bar**</i>	975 - 990 mm	£1,179
FXDEC120..	Fixed Panel <b>1200 mm x 2100 mm</b> <i>**FXSBCRS - Across Support Bar**</i>	1175 - 1190 mm	£1,278
FXDEC140..	Fixed Panel <b>1400 mm x 2100 mm</b> <i>**FXSBCRS - Across Support Bar**</i>	1375 - 1390 mm	£1,378

Please NOTE Support bars are included on price as per Product descriptions. For dimensions that do not fit our Standard range please contact us, we are experts on Bespoke and made to measure projects. Please email us at [sales@drenchshowers.co.uk](mailto:sales@drenchshowers.co.uk).

### MATTE Colours available

	BK	<b>Matt Black</b>	RAL 9005
	GG	<b>Graphite Grey</b>	RAL 7024
	GM	<b>Gun Metal</b>	RAL 8019
	BO	<b>Burnt Orange</b>	RAL 3022
	LY	<b>Lemon Yellow</b>	RAL 1012
	PP	<b>Pale Pink</b>	RAL 3015
	BL	<b>Blanc</b>	RAL 9002
	TT	<b>Total White</b>	RAL 9003
	MI	<b>Mint</b>	RAL 6019
	FO	<b>Forest</b>	RAL 6009
	CB	<b>Capri Blue</b>	RAL 5019
	GN	<b>Grey Navy</b>	RAL 5008

Any RAL Classic colours are available **plus 35% to prices above**. For both RAL and Glass Option together please add **65% to prices above**.

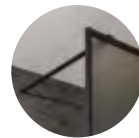

**FXSBCRS**  
Across Support Bar  
1000 mm



**FXSBNGL**  
Angle Support Bar  
450 mm

### Metalwork Design layout

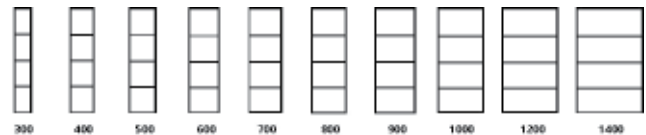

### Glass Options available

Please NOTE other Glass options are available plus additional surcharge to prices listed above.

Plus 45% additional

Plus 35% additional

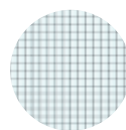

**Cross Fluted**  
8.8 mm TGH  
Laminated



**Fluted**  
8.8 mm TGH  
Laminated



**Frosted**  
8 mm TGH  
Satin Etch

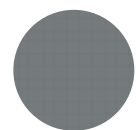

**Grey Tinted**  
8 mm TGH  
Smoked glass



## Fixed Panels with Flipper Panel

**Flipper panel is delivered already assembled to the fixed panel.**

It cannot be installed retrospectively. The pivot mechanism is adjustable from 0 to 180 degree position.

# MATTE Colours



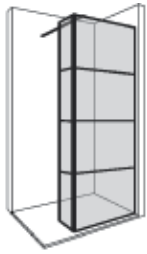

# DECO MATTE Colours

## Fixed Panels with Flipper

Please choose your codes depending on width required and add the two letter colour code to it.  
**NOTE This item is Handed so Left or Right Hand need to be specified.**



LH  
Left Hand



RH  
Right Hand

Item Code	Description	Adjustment Range	Retail Price Exc VAT (Clear Glass)
FXDEC30FLIPL.. FXDEC30FLIPR..	Fixed Panel <b>300 x 2100 mm with 300 Flipper.</b> R: Right Hand wall fixing / L: Left Hand wall fixing **FXSBNGL - Angle Support Bar**	580 - 590 mm	£959
FXDEC40FLIPL.. FXDEC40FLIPR..	Fixed Panel <b>400 x 2100 mm with 300 Flipper.</b> R: Right Hand wall fixing / L: Left Hand wall fixing **FXSBNGL - Angle Support Bar**	680 - 690 mm	£983
FXDEC50FLIPL.. FXDEC50FLIPR..	Fixed Panel <b>500 x 2100 mm with 300 Flipper.</b> R: Right Hand wall fixing / L: Left Hand wall fixing **FXSBCRS - Across Support Bar**	780 - 790 mm	£1,038
FXDEC60FLIPL.. FXDEC60FLIPR..	Fixed Panel <b>600 x 2100 mm with 300 Flipper.</b> R: Right Hand wall fixing / L: Left Hand wall fixing **FXSBCRS - Across Support Bar**	880 - 890 mm	£1,084
FXDEC70FLIPL.. FXDEC70FLIPR..	Fixed Panel <b>700 x 2100 mm with 300 Flipper.</b> R: Right Hand wall fixing / L: Left Hand wall fixing **FXSBCRS - Across Support Bar**	980 - 990 mm	£1,128
FXDEC80FLIPL.. FXDEC80FLIPR..	Fixed Panel <b>800 x 2100 mm with 300 Flipper.</b> R: Right Hand wall fixing / L: Left Hand wall fixing **FXSBCRS - Across Support Bar**	1080 - 1090 mm	£1,367
FXDEC90FLIPL.. FXDEC90FLIPR..	Fixed Panel <b>900 x 2100 mm with 300 Flipper.</b> R: Right Hand wall fixing / L: Left Hand wall fixing **FXSBCRS - Across Support Bar**	1180 - 1190 mm	£1,409
FXDEC100FLIPL.. FXDEC100FLIPR..	Fixed Panel <b>1000 x 2100 mm with 300 Flipper.</b> R: Right Hand wall fixing / L: Left Hand wall fixing **FXSBCRS - Across Support Bar**	1280 - 1290 mm	£1,441
FXDEC120FLIPL.. FXDEC120FLIPR..	Fixed Panel <b>1200 x 2100 mm with 300 Flipper.</b> R: Right Hand wall fixing / L: Left Hand wall fixing **FXSBCRS - Across Support Bar**	1480 - 1490 mm	£1,536
FXDEC140FLIPL.. FXDEC140FLIPR..	Fixed Panel <b>1400 x 2100 mm with 300 Flipper.</b> R: Right Hand wall fixing / L: Left Hand wall fixing **FXSBCRS - Across Support Bar**	1680 - 1690 mm	£1,626

Please NOTE Support bars are included on price as per Product descriptions.  
 For dimensions that do not fit our Standard range please email us at [sales@drenchshowers.co.uk](mailto:sales@drenchshowers.co.uk).

### MATTE Colours available

	BK	<b>Matt Black</b>	RAL 9005
	GG	<b>Graphite Grey</b>	RAL 7024
	GM	<b>Gun Metal</b>	RAL 8019
	BO	<b>Burnt Orange</b>	RAL 3022
	LY	<b>Lemon Yellow</b>	RAL 1012
	PP	<b>Pale Pink</b>	RAL 3015
	BL	<b>Blanc</b>	RAL 9002
	TT	<b>Total White</b>	RAL 9003
	MI	<b>Mint</b>	RAL 6019
	FO	<b>Forest</b>	RAL 6009
	CB	<b>Capri Blue</b>	RAL 5019
	GN	<b>Grey Navy</b>	RAL 5008

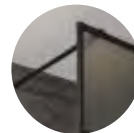

**FXSBCRS**  
Across Support Bar  
1000 mm



**FXSBNGL**  
Angle Support Bar  
450 mm

### Metalwork Design layout

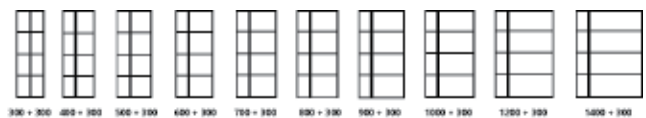

### Glass Options available

Please NOTE other Glass options are available plus additional surcharge to prices listed above.

Plus 45% additional      Plus 35% additional

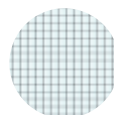

**Cross Fluted**  
8.8 mm TGH  
Laminated



**Fluted**  
8.8 mm TGH  
Laminated



**Frosted**  
8 mm TGH  
Satin Etch



**Grey Tinted**  
8 mm TGH  
Smoked glass

Any RAL Classic colours are available **plus 35% to prices above**. For both RAL and Glass Option together please add **65% to prices above**.

# DECO MATTE Colours



## Free Standing Panels

**Free standing Shower Screen** for Wet rooms and walk-in showers.  
2 Across Support bars included in price.

Please add the two letter colour code to your code chosen above.

Item Code	Description	Physical width of Unit	Retail Price Exc VAT (Clear Glass)
FXDEC80FST..	Free Standing Panel <b>800 mm x 2100 mm</b> **2 x FXSBCRS - Across Support Bar**	762 mm	£1,081
FXDEC90FST..	Free Standing Panel <b>900 mm x 2100 mm</b> **2 x FXSBCRS - Across Support Bar**	862 mm	£1,131
FXDEC100FST..	Free Standing Panel <b>1000 mm x 2100 mm</b> **2 x FXSBCRS - Across Support Bar**	962 mm	£1,179
FXDEC120FST..	Free Standing Panel <b>1200 mm x 2100 mm</b> **2 x FXSBCRS - Across Support Bar**	1162 mm	£1,278
FXDEC140FST..	Free Standing Panel <b>1400 mm x 2100 mm</b> **2 x FXSBCRS - Across Support Bar**	1362 mm	£1,378

Please NOTE Support bars are included on price as per Product descriptions.  
For dimensions that do not fit our Standard range please contact us, we are experts on Bespoke and made to measure projects.  
Please email us at [sales@drenchshowers.co.uk](mailto:sales@drenchshowers.co.uk).

### MATTE Colours available

	BK	<b>Matt Black</b>	RAL 9005
	GG	<b>Graphite Grey</b>	RAL 7024
	GM	<b>Gun Metal</b>	RAL 8019
	BO	<b>Burnt Orange</b>	RAL 3022
	LY	<b>Lemon Yellow</b>	RAL 1012
	PP	<b>Pale Pink</b>	RAL 3015
	BL	<b>Blanc</b>	RAL 9002
	TT	<b>Total White</b>	RAL 9003
	MI	<b>Mint</b>	RAL 6019
	FO	<b>Forest</b>	RAL 6009
	CB	<b>Capri Blue</b>	RAL 5019
	GN	<b>Grey Navy</b>	RAL 5008

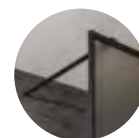

**FXSBCRS (x2)**  
Across Support Bar  
1000 mm

### Metalwork Design layout

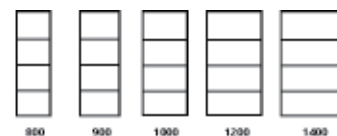

### Glass Options available

Please NOTE other Glass options are available plus additional surcharge to prices listed above.

Plus 45% additional

Plus 35% additional

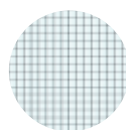

**Cross Fluted**  
8.8 mm TGH  
Laminated



**Fluted**  
8.8 mm TGH  
Laminated



**Frosted**  
8 mm TGH  
Satin Etch



**Grey Tinted**  
8 mm TGH  
Smoked glass

Any RAL Classic colours are available **plus 35% to prices above**. For both RAL and Glass Option together please add 65% to prices above.





# MATTE Colours

## Support Bars for Panel Combinations

DRENCH Shower panels can be used individually or combined to recreate a walk-in shower space. When Shower panels are ordered individually support bars required for installation are included in the price and supplied by DRENCH.

When Shower Panels are combined, possibilities are endless hence we have designed a range of accessories suitable for any design or configuration.

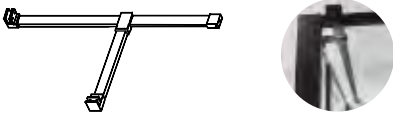
All support bars and fixings are supplied in same colour/finish as the Shower panel.

Item Code	Item Description	Specification	Retail Price Metallic Finishes (Exc VAT)
FXSBNGL..	<b>90° Angle Support Bar</b> (3 components, not pre-assembled) 450 mm length, 30 x 10 mm bar. **Not suitable for panels wider than 1000 mm**		£99
FXSBTBAR..	<b>T Shape Support bar</b> (4 components, not pre-assembled) 2x 30 x 10 mm bars. Long bar 1200 mm + Short bar at 1000 mm **Suitable for Shower Panels combinations**		£139
PR758..	<b>Corner Channel</b> for L Shape configurations Wall Fixings included. <b>2100 mm standard length</b>		£128

### Shower Panels Combinations Sample Layouts

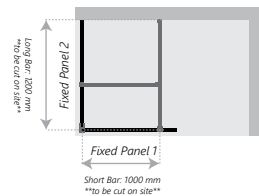
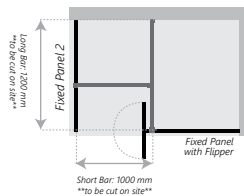
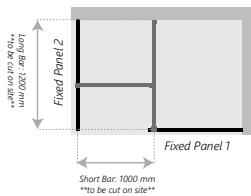

For Walk-In showers with Wall Fixed panels, **T Shape support bar (FXSBT-BAR..)** is recommended for installation purposes.

Please note the TBAR includes 2 bars at 1200 and 1000 mm. These bars can be trimmed on site to fit most of standard walk in shower dimensions.

For Walk-In showers with Wall Fixed panels and Fixed Panel with Flipper, **T Shape support bar (FXSBT-BAR..)** is recommended for installation purposes.

Please note the TBAR includes 2 bars at 1200 and 1000 mm. These bars can be trimmed on site to fit most of standard walk in shower dimensions.

For L-Shape configurations with Wall Fixed panels, **Corner channel (PR758)** and extra **T Shape support bar (FXSBT-BAR..)** is recommended for installation purposes.

Please note the TBAR includes 2 bars at 1200 and 1000 mm. These bars can be trimmed on site to fit most of standard walk in shower dimensions.



## Wall Fixed Panels

Panel is attached to the Wall using Wall Channel and Support Bar.

## Metallic Finishes





# DECO Metallic Finishes

## Wall Fixed Panels

Please choose your codes depending on width required and add the two letter colour code to it.





Prices below are RRP exc VAT for CLEAR GLASS, other GLASS OPTIONS are available plus additional surcharge.

Item Code	Description	Adjustment Range	Retail Price Exc VAT (Clear Glass)
FXDEC30..	Fixed Panel <b>300 mm x 2100 mm</b> <i>**No support Bar Included**</i>	275 - 290 mm	£920
FXDEC40..	Fixed Panel <b>400 mm x 2100 mm</b> <i>**No support Bar Included**</i>	375 - 390 mm	£982
FXDEC50..	Fixed Panel <b>500 mm x 2100 mm</b> <i>**FXSBCRS - Across Support Bar**</i>	475 - 490 mm	£1,043
FXDEC60..	Fixed Panel <b>600 mm x 2100 mm</b> <i>**FXSBCRS - Across Support Bar**</i>	575 - 590 mm	£1,109
FXDEC70..	Fixed Panel <b>700 mm x 2100 mm</b> <i>**FXSBCRS - Across Support Bar**</i>	675 - 690 mm	£1,170
FXDEC80..	Fixed Panel <b>800 mm x 2100 mm</b> <i>**FXSBCRS - Across Support Bar**</i>	775 - 790 mm	£1,568
FXDEC90..	Fixed Panel <b>900 mm x 2100 mm</b> <i>**FXSBCRS - Across Support Bar**</i>	875 - 890 mm	£1,644
FXDEC100..	Fixed Panel <b>1000 mm x 2100 mm</b> <i>**FXSBCRS - Across Support Bar**</i>	975 - 990 mm	£1,722
FXDEC120..	Fixed Panel <b>1200 mm x 2100 mm</b> <i>**FXSBCRS - Across Support Bar**</i>	1175 - 1190 mm	£1,775
FXDEC140..	Fixed Panel <b>1400 mm x 2100 mm</b> <i>**FXSBCRS - Across Support Bar**</i>	1375 - 1390 mm	£1,829

Please NOTE Support bars are included on price as per Product descriptions. For dimensions that do not fit our Standard range please contact us, we are experts on Bespoke and made to measure projects.

Please email us at [sales@drenchshowers.co.uk](mailto:sales@drenchshowers.co.uk).

### Metallic Finishes available

	LB	<b>Light Bronze</b>	Anodised
	DB	<b>Dark Bronze</b>	Anodised
	BS	<b>Brushed Steel</b>	Anodised
	BB	<b>Brushed Brass</b>	Anodised



**FXSBCRS**  
Across Support Bar  
1000 mm

### Metalwork Design layout

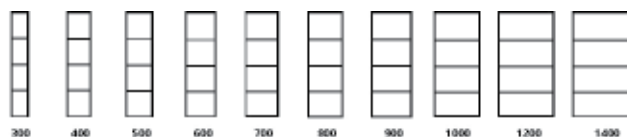

### Glass Options available

Please NOTE other Glass options are available plus additional surcharge to prices listed above.

Plus 45% additional

Plus 35% additional

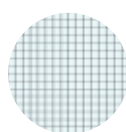

**Cross Fluted**  
8.8 mm TGH  
Laminated



**Fluted**  
8.8 mm TGH  
Laminated



**Frosted**  
8 mm TGH  
Satin Etch



**Grey Tinted**  
8 mm TGH  
Smoked glass



## Fixed Panels with Flipper Panel

**Flipper panel is delivered already assembled to the fixed panel.**

It cannot be installed retrospectively.  
The pivot mechanism is adjustable from 0 de to 180 degree position.

# Metallic Finishes





# DECO Metallic Finishes

## Fixed Panels with Flipper

Please choose your codes depending on width required and add the two letter colour code to it.  
**NOTE This item is Handed so Left or Right Hand need to be specified.**



**LH**  
Left Hand







**RH**  
Right Hand

Item Code	Description	Adjustment Range	Retail Price Exc VAT (Clear Glass)
FXDEC30FLIPL.. FXDEC30FLIPR..	Fixed Panel <b>300 x 2100 mm with 300 Flipper.</b> R: Right Hand wall fixing / L: Left Hand wall fixing **FXSBCRS - Across Support Bar**	580 - 590 mm	£1,410
FXDEC40FLIPL.. FXDEC40FLIPR..	Fixed Panel <b>400 x 2100 mm with 300 Flipper.</b> R: Right Hand wall fixing / L: Left Hand wall fixing **FXSBCRS - Across Support Bar**	680 - 690 mm	£1,445
FXDEC50FLIPL.. FXDEC50FLIPR..	Fixed Panel <b>500 x 2100 mm with 300 Flipper.</b> R: Right Hand wall fixing / L: Left Hand wall fixing **FXSBCRS - Across Support Bar**	780 - 790 mm	£1,525
FXDEC60FLIPL.. FXDEC60FLIPR..	Fixed Panel <b>600 x 2100 mm with 300 Flipper.</b> R: Right Hand wall fixing / L: Left Hand wall fixing **FXSBCRS - Across Support Bar**	880 - 890 mm	£1,594
FXDEC70FLIPL.. FXDEC70FLIPR..	Fixed Panel <b>700 x 2100 mm with 300 Flipper.</b> R: Right Hand wall fixing / L: Left Hand wall fixing **FXSBCRS - Across Support Bar**	980 - 990 mm	£1,659
FXDEC80FLIPL.. FXDEC80FLIPR..	Fixed Panel <b>800 x 2100 mm with 300 Flipper.</b> R: Right Hand wall fixing / L: Left Hand wall fixing **FXSBCRS - Across Support Bar**	1080 - 1090 mm	£1,827
FXDEC90FLIPL.. FXDEC90FLIPR..	Fixed Panel <b>900 x 2100 mm with 300 Flipper.</b> R: Right Hand wall fixing / L: Left Hand wall fixing **FXSBCRS - Across Support Bar**	1180 - 1190 mm	£1,899
FXDEC100FLIPL.. FXDEC100FLIPR..	Fixed Panel <b>1000 x 2100 mm with 300 Flipper.</b> R: Right Hand wall fixing / L: Left Hand wall fixing **FXSBCRS - Across Support Bar**	1280 - 1290 mm	£1,978
FXDEC120FLIPL.. FXDEC120FLIPR..	Fixed Panel <b>1200 x 2100 mm with 300 Flipper.</b> R: Right Hand wall fixing / L: Left Hand wall fixing **FXSBCRS - Across Support Bar**	1480 - 1490 mm	£2,134
FXDEC140FLIPL.. FXDEC140FLIPR..	Fixed Panel <b>1400 x 2100 mm with 300 Flipper.</b> R: Right Hand wall fixing / L: Left Hand wall fixing **FXSBCRS - Across Support Bar**	1680 - 1690 mm	£2,278

Please NOTE Support bars are included on price as per Product descriptions.  
 For dimensions that do not fit our Standard range please email us at [sales@drenchshowers.co.uk](mailto:sales@drenchshowers.co.uk).

### Metallic Finishes available

	LB	<b>Light Bronze</b>	Anodised
	DB	<b>Dark Bronze</b>	Anodised
	BS	<b>Brushed Steel</b>	Anodised
	BB	<b>Brushed Brass</b>	Anodised



**FXSBCRS**  
Across Support Bar  
1000 mm

### Metalwork Design layout

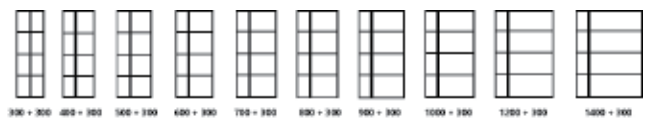

### Glass Options available

Please NOTE other Glass options are available plus additional surcharge to prices listed above.

Plus 45% additional

Plus 35% additional

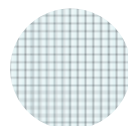

**Cross Fluted**

8.8 mm TGH  
Laminated



**Fluted**

8.8 mm TGH  
Laminated



**Frosted**

8 mm TGH  
Satin Etch

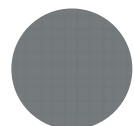

**Grey Tinted**

8 mm TGH  
Smoked glass



# DECO Metallic Finishes



## Free Standing Panels





**Free standing Shower Screen** for Wet rooms and walk-in showers.  
2 Across Support bars included in price.

Please add the two letter colour code to your code chosen above.

Item Code	Description	Physical width of Unit	Retail Price Exc VAT (Clear Glass)
FXDEC80FST..	Free Standing Panel <b>800 mm x 2100 mm</b> **2 x FXSBCRS - Across Support Bar**	762 mm	£1,568
FXDEC90FST..	Free Standing Panel <b>900 mm x 2100 mm</b> **2 x FXSBCRS - Across Support Bar**	862 mm	£1,644
FXDEC100FST..	Free Standing Panel <b>1000 mm x 2100 mm</b> **2 x FXSBCRS - Across Support Bar**	962 mm	£1,722
FXDEC120FST..	Free Standing Panel <b>1200 mm x 2100 mm</b> **2 x FXSBCRS - Across Support Bar**	1162 mm	£1,775
FXDEC140FST..	Free Standing Panel <b>1400 mm x 2100 mm</b> **2 x FXSBCRS - Across Support Bar**	1362 mm	£1,829

Please NOTE Support bars are included on price as per Product descriptions.  
For dimensions that do not fit our Standard range please contact us, we are experts on Bespoke and made to measure projects.  
Please email us at [sales@drenchshowers.co.uk](mailto:sales@drenchshowers.co.uk).

### Metallic Finishes available

	LB	<b>Light Bronze</b>	Anodised
	DB	<b>Dark Bronze</b>	Anodised
	BS	<b>Brushed Steel</b>	Anodised
	BB	<b>Brushed Brass</b>	Anodised



**FXSBCRS**  
Across Support Bar  
1000 mm

### Metalwork Design layout

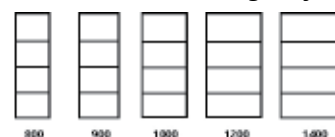

### Glass Options available

Please NOTE other Glass options are available plus additional surcharge to prices listed above.

Plus 45% additional

Plus 35% additional

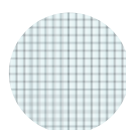

**Cross Fluted**  
8.8 mm TGH  
Laminated



**Fluted**  
8.8 mm TGH  
Laminated



**Frosted**  
8 mm TGH  
Satin Etch



**Grey Tinted**  
8 mm TGH  
Smoked glass







# Metallic Finishes

## Support Bars for Panel Combinations

DRENCH Shower panels can be used individually or combined to recreate a walk-in shower space. When Shower panels are ordered individually support bars required for installation are included in the price and supplied by DRENCH.

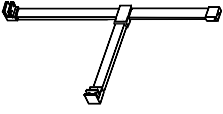
When Shower Panels are combined, possibilities are endless hence we have designed a range of accessories suitable for any design or configuration.

All support bars and fixings are supplied in same colour/finish as the Shower panel.

Item Code	Item Description	Specification	Retail Price Metallic Finishes (Exc VAT)
FXSBTBAR..	<b>T Shape Support bar</b> (4 components, not pre-assembled) 2x 30 x 10 mm bars. Long bar 1200 mm + Short bar at 1000 mm **Suitable for Shower Panels combinations**	 	<b>£235</b>
PR758..	<b>Corner Channel</b> for L Shape configurations Wall Fixings included. <b>2100 mm standard length</b>	 	<b>£213</b>

### Shower Panels Combinations Sample Layouts

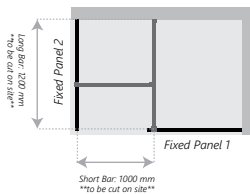

For Walk-In showers with Wall Fixed panels, **T Shape support bar (FXSBT-BAR..)** is recommended for installation purposes.

Please note the T BAR includes 2 bars at 1200 and 1000 mm.

These bars can be trimmed on site to fit most of standard walk in shower dimensions.

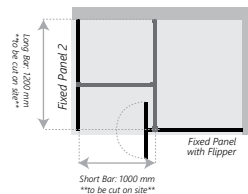

For Walk-In showers with Wall Fixed panels and Fixed Panel with Flipper, **T Shape support bar (FXSBT-BAR..)** is recommended for installation purposes.

Please note the T BAR includes 2 bars at 1200 and 1000 mm.

These bars can be trimmed on site to fit most of standard walk in shower dimensions.

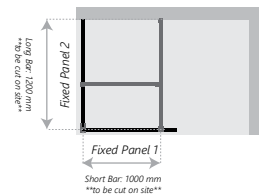

For L-Shape configurations with Wall Fixed panels, **Corner channel (PR758)** and extra **T Shape support bar (FXSBT-BAR..)** is recommended for installation purposes.

Please note the T BAR includes 2 bars at 1200 and 1000 mm.

These bars can be trimmed on site to fit most of standard walk in shower dimensions.



## Bath Screens



**DECO**  
MATTE Colours

There is really nothing better than a nice long soak in the tub after a long and stressful day.

We love the idea we can contribute to make your bathtub look different with our range of Bath Screens.

DRENCH Bath Screens are available in pretty much all collections plus you can choose between 12 MATTE Colour options, 6 Metallic Finishes and our gorgeous glass options like Fluted, Frosted and Grey Tinted Glass.



**Fixed Bath Screen**  
Wall Fixed channel  
Included

**Fixed Bath screen** are a reduced version or our **Wall fixed** panels suitable to be installed onto a bath. This configuration ticks the box for small bathrooms.

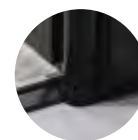

**Pivot hinged  
Bath Screen**

**Pivot Bath Screens** are hinged to the wall and swing **180 degrees**. Pivot bath screens are handed so make sure you choose the **Left or Right** hand code when ordering.

There is a 10 mm gap between the bottom profile and the top of the bath to allow the pivot mechanism work. A black rubber seal is supplied with the screen to cover the gap and guarantee watertight conditions.



# DECO MATTE Colours

## Bath Screens

**Both pivot and fixed bath screen options available.**  
Please add the two letter colour code to your code chosen above.

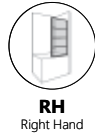

Item Code	Description	Adjustment Range	Retail Price Exc VAT (Clear Glass)
<b>DECFXBAT..</b>	Fixed Bath Screen <b>800 x 1500 mm</b>	760 - 780 mm	£663
<b>DECBATL..</b> <b>DECBATR..</b>	Pivot Hinged Bath Screen <b>800 x 1500 mm</b> L Left Hand / R Right Hand	760 - 780 mm	£700

For dimensions that do not fit our Standard range please contact us, we are experts on Bespoke and made to measure projects.  
Please email us at [sales@drenchshowers.co.uk](mailto:sales@drenchshowers.co.uk).

### MATTE Colours available

	BK	<b>Matt Black</b>	RAL9005
	GG	<b>Graphite Grey</b>	RAL7024
	GM	<b>Gun Metal</b>	RAL 8019
	BO	<b>Burnt Orange</b>	RAL 3022
	LY	<b>Lemon Yellow</b>	RAL 1012
	PP	<b>Pale Pink</b>	RAL 3015
	BL	<b>Blanc</b>	RAL 9002
	TT	<b>Total White</b>	RAL9003
	MI	<b>Mint</b>	RAL 6019
	FO	<b>Forest</b>	RAL 6009
	CB	<b>Capri Blue</b>	RAL 5019
	GN	<b>Grey Navy</b>	RAL 5008

### Metalwork Design layout



### Glass Options available

Please NOTE other Glass options are available plus additional surcharge to prices listed above.

Plus 45% additional

Plus 35% additional

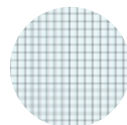

**Cross Fluted**  
8.8 mm TGH  
Laminated



**Fluted**  
8.8 mm TGH  
Laminated



**Frosted**  
8 mm TGH  
Satin Etch

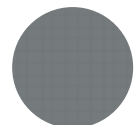

**Grey Tinted**  
8 mm TGH  
Smoked glass

Any RAL Classic colours are available **plus 35% to prices above**. For both RAL and Glass Option together please add **65% to prices above**.



## Bath Screens



**DECO**  
Metallic Finishes

There is really nothing better than a nice long soak in the tub after a long and stressful day.

We love the idea we can contribute to make your bathtub look different with our range of Bath Screens.

DRENCH Bath Screens are available in pretty much all collections plus you can choose between 12 MATTE Colour options, 6 Metallic Finishes and our gorgeous glass options like Fluted, Frosted and Grey Tinted Glass.



**Fixed Bath Screen**  
Wall Fixed channel  
Included

**Fixed Bath screen** are a reduced version or our **Wall fixed** panels suitable to be installed onto a bath. This configuration ticks the box for small bathrooms.

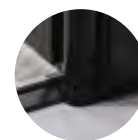

**Pivot Hinge Bath Screen**

**Pivot Bath Screens** are hinged to the wall and swing **180 degrees**. Pivot bath screens are handed so make sure you choose the **Left or Right** hand code when ordering.

There is a 10 mm gap between the bottom profile and the top of the bath to allow the pivot mechanism work. A black rubber seal is supplied with the screen to cover the gap and guarantee watertight conditions.



# DECO Metallic Finishes

## Bath Screens



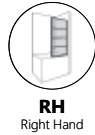
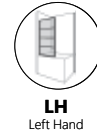

**Both pivot and fixed bath screen options available.**  
Please add the two letter colour code to your code chosen above.



Item Code	Description	Adjustment Range	Retail Price Exc VAT (Clear Glass)
<b>DECFXBAT..</b>	Fixed Bath Screen <b>800 x 1500 mm</b>	760 - 780 mm	<b>£895</b>
<b>DECBATL..</b> <b>DECBATR..</b>	Pivot Hinged Bath Screen <b>800 x 1500 mm</b> L Left Hand / R Right Hand	760 - 780 mm	<b>£981</b>

For dimensions that do not fit our Standard range please contact us, we are experts on Bespoke and made to measure projects.  
Please email us at [sales@drenchshowers.co.uk](mailto:sales@drenchshowers.co.uk).

### Metallic Finishes available

	LB	<b>Light Bronze</b>	Anodised
	DB	<b>Dark Bronze</b>	Anodised
	BS	<b>Brushed Steel</b>	Anodised
	BB	<b>Brushed Brass</b>	Anodised

### Metalwork Design layout



### Glass Options available

Please NOTE other Glass options are available plus additional surcharge to prices listed above.

Plus 45% additional

Plus 35% additional

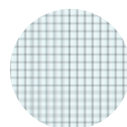

**Cross Fluted**  
8.8 mm TGH  
Laminated



**Fluted**  
8.8 mm TGH  
Laminated



**Frosted**  
8 mm TGH  
Satin Etch

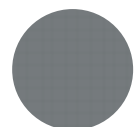

**Grey Tinted**  
8 mm TGH  
Smoked glass

# Single Shower Doors

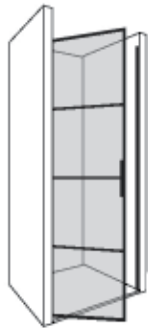

**LH**  
Left Hand

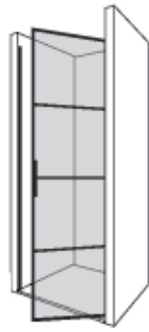

**RH**  
Right Hand

Single doors are suitable for shower recesses. **Left** or **Right** hand options are available.

Doors are built using our **pivot hinge**. The 5 mm rise and fall mechanism is manufactured using zinc die castings which give a durable and strong door performance. The **magnetic closing** creates a secure seal after the shower door is closed.

**Pull handle, fixings and door seal are included in the price below.**



Item Code	Description	Adjustment Range		Retail Price Exc VAT (Clear Glass)
		In a recess	With Return Panel	
DECDOR70L.. DECDOR70R..	Shower Door <b>700 x 2100 mm</b> , L Left Hand / R Right Hand	667 - 699 mm	675 - 690 mm	£913
DECDOR76L.. DECDOR76R..	Shower Door <b>760 x 2100 mm</b> , L Left Hand / R Right Hand	727 - 759 mm	735 - 750 mm	£1,126
DECDOR80L.. DECDOR80R..	Shower Door <b>800 x 2100 mm</b> , L Left Hand / R Right Hand	767 - 799 mm	775 - 790 mm	£1,146
DECDOR90L.. DECDOR90R..	Shower Door <b>900 x 2100 mm</b> , L Left Hand / R Right Hand	867 - 899 mm	875 - 890 mm	£1,184

Please choose your codes depending on width required and add the two letter colour code to it.

**NOTE This item is Handed so Left or Right Hand need to be specified.**

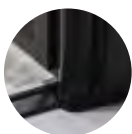

### Pivot hinge

Our Pivot hinge system with a 5 mm rise and fall mechanism. **Pivot swing can be set from 0 to 180 degree position.**

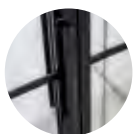

### PHAND

Minimalistic pull handle. Mechanically fixed to Closing Post.

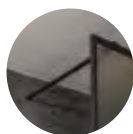

### FXSBCRS

Across Support Bar 1000 mm

**\*\*When Door paired with Return Panel\*\***

### Metalwork Design layout

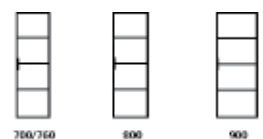

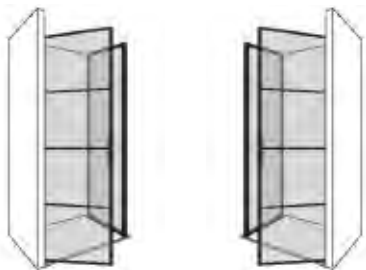

# Return Panels for Shower Doors Enclosures



Shower doors may be paired with a range of Return/Side Panels to create Shower Cubicles. Return panels must be ordered with the door.  
If you want to create a Shower Enclosure please follow the steps below:

1. Choose your Door size, handing, colour and glass option and keep the code.
2. Choose the Return size check the hand required and keep the code. Our handing is based on the wall fixing position when you look at it from the outside.
3. Specify both codes on your order and DRENCH will make sure the correct Shower cubicle is delivered including wall fixings, handle and Support bars required.

Item Code	Description	Adjustment Range	Retail Price Exc VAT (Clear Glass)
+DEC70L.. +DEC70R..	Return Panel <b>700 x 2100 mm</b> L Left Hand / R Right Hand <i>**FXSBCRS - Across Support Bar**</i>	675 - 690 mm	£801
+DEC80L.. +DEC80R..	Return Panel <b>800 x 2100 mm</b> L Left Hand / R Right Hand <i>**FXSBCRS - Across Support Bar**</i>	775 - 780 mm	£836
+DEC90L.. +DEC90R..	Return Panel <b>900 x 2100 mm</b> L Left Hand / R Right Hand <i>**FXSBCRS - Across Support Bar**</i>	875 - 890 mm	£859
+DEC100L.. +DEC100R..	Return Panel <b>1000 x 2100 mm</b> L Left Hand / R Right Hand <i>**FXSBCRS - Across Support Bar**</i>	975 - 990 mm	£922

For dimensions that do not fit our Standard range please contact us, We are experts on Bespoke and made to measure projects. Please email us at [sales@drenchshowers.co.uk](mailto:sales@drenchshowers.co.uk).

## Metalwork Design layout



## MATTE Colours available

BK	<b>Matt Black</b>	RAL 9005
GG	<b>Graphite Grey</b>	RAL 7024
GM	<b>Gun Metal</b>	RAL 8019
BO	<b>Burnt Orange</b>	RAL 3022
LY	<b>Lemon Yellow</b>	RAL 1012
PP	<b>Pale Pink</b>	RAL 3015
BL	<b>Blanc</b>	RAL 9002
TT	<b>Total White</b>	RAL 9003
MI	<b>Mint</b>	RAL 6019
FO	<b>Forest</b>	RAL 6009
CB	<b>Capri Blue</b>	RAL 5019
GN	<b>Grey Navy</b>	RAL 5008

## Shower Door with Return Panel Configurations

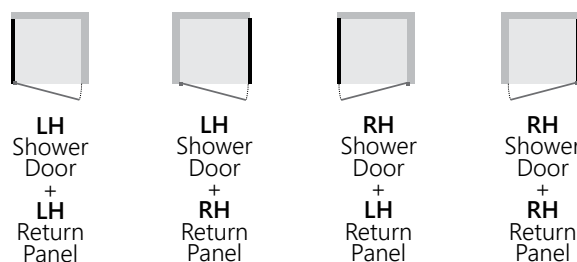

## Glass Options available

Please NOTE other Glass options are available plus additional surcharge to prices listed above.

Plus 45% additional		Plus 35% additional	
	<b>Cross Fluted</b> 8.8 mm TGH Laminated		<b>Fluted</b> 8.8 mm TGH Laminated
	<b>Frosted</b> 8 mm TGH Satin Etch		<b>Grey Tinted</b> 8 mm TGH Smoked glass

Any RAL Classic colours are available **plus 35% to prices above**. For both RAL and Glass Option together please add **65% to prices above**.

# Shower Door with Inline panel



**DECO  
MATTE Colours**

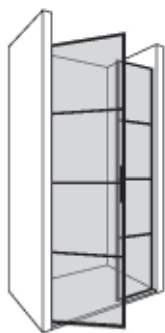

**LH**  
Left Hand

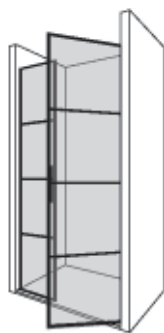

**RH**  
Right Hand

Door is hinged to the wall closing onto an Inline panel. Left or Right hand options are available.

Doors are built using our **pivot hinge**. The 5 mm rise and fall mechanism is manufactured using zinc die castings which give a durable and strong door performance. The **magnetic closing** creates a secure seal after the shower door is closed.

**Pull handle, fixings and door seal are included in the price below.**



Item Code	Description	Adjustment Range	Adjustment Range	Retail Price Exc VAT (Clear Glass)
		In a recess	With Return Panel	
DECDI70/20L.. DECDI70/20R..	Door with Inline <b>900 x 2100 mm</b> (700 mm Door + 200 mm Inline Panel) L Left Hand / R Right Hand <b>**FXSBPRL - Parallel Support Bar included **</b>	867 - 899 mm	875 - 890 mm	£1,223
DECDI70/30L.. DECDI70/30R..	Door with Inline <b>1000 x 2100 mm</b> (700 mm Door + 300 mm Inline Panel) L Left Hand / R Right Hand <b>**FXSBPRL - Parallel Support Bar included **</b>	967 - 999 mm	975 - 990 mm	£1,350
DECDI90/30L.. DECDI90/30R..	Door with Inline <b>1200 x 2100 mm</b> (900 mm Door + 300 mm Inline Panel) L Left Hand / R Right Hand <b>**FXSBPRL - Parallel Support Bar included **</b>	1167 - 1199 mm	1175 - 1190 mm	£1,585
DECDI70/70L.. DECDI70/70R..	Door with Inline <b>1400 x 2100 mm</b> (700 mm Door + 700 mm Inline Panel) L Left Hand / R Right Hand <b>**FXSBPRL - Parallel Support Bar included **</b>	1367 - 1399 mm	1375 - 1390 mm	£1,915
DECDI90/60L.. DECDI90/60R..	Door with Inline <b>1500 x 2100 mm</b> (900 mm Door + 600 mm Inline Panel) L Left Hand / R Right Hand <b>**FXSBPRL - Parallel Support Bar included **</b>	1467 - 1499 mm	1475 - 1490 mm	£2,033
DECDI90/70L.. DECDI90/70R..	Door with Inline <b>1600 x 2100 mm</b> (900 mm Door + 700 mm Inline Panel) L Left Hand / R Right Hand <b>**FXSBPRL - Parallel Support Bar included **</b>	1567 - 1599 mm	1575 - 1590 mm	£2,254

All of our shower doors are Opening OUT, please contact us if Opening INWARDS is required. Please choose your codes depending on width required and add the two letter colour code to it.

**NOTE This item is Handed so Left or Right Hand need to be specified.**

## Metalwork Design layout

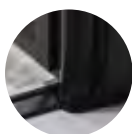

### Pivot hinge

Our Pivot hinge system with a 5 mm rise and fall mechanism. **Pivot swing can be set from 0 to 180 degree position.**

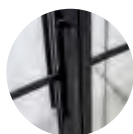

### PHAND

Minimalistic pull handle. Mechanically fixed to Closing Post.



### FXSBPRL

Parallel Support Bar 2000 mm  
(To be trimmed on site)

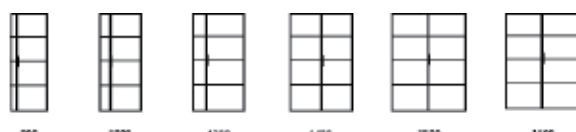



# Return Panels for Shower Door with Inline Enclosures



Shower doors with inline panel may be paired with a range of Return/Side Panels to create shower cubicles.

**Return panels must be ordered with the door.** If you want to create a Shower Enclosure please follow the steps below:

**1. Choose your Door with Inline size,** handing, colour and glass option and keep the code.

**2. Choose the Return size,** check the hand required and keep the code.

*\*\*Our handing is based on the wall fixing position when you look at it from the outside.\*\**

**3. Specify both codes** on your order and DRENCH will make sure the correct Shower cubicle is delivered including wall fixings, handle and Support bars required.

Item Code	Description	Adjustment Range	Retail Price Exc VAT (Clear Glass)
+DEC70L.. +DEC70R..	Return Panel <b>700 x 2100 mm</b> L Left Hand / R Right Hand <i>**FXSBDBL - Return Panel Support Bar**</i>	675 - 690 mm	£801
+DEC80L.. +DEC80R..	Return Panel <b>800 x 2100 mm</b> L Left Hand / R Right Hand <i>**FXSBDBL - Return Panel Support Bar**</i>	775 - 780 mm	£836
+DEC90L.. +DEC90R..	Return Panel <b>900 x 2100 mm</b> L Left Hand / R Right Hand <i>**FXSBDBL - Return Panel Support Bar**</i>	875 - 890 mm	£859
+DEC100L.. +DEC100R..	Return Panel <b>1000 x 2100 mm</b> L Left Hand / R Right Hand <i>**FXSBDBL - Return Panel Support Bar**</i>	975 - 990 mm	£922

*For dimensions that do not fit our Standard range please contact us, We are experts on Bespoke and made to measure projects. Please email us at [sales@drenchshowers.co.uk](mailto:sales@drenchshowers.co.uk).*

## MATTE Colours available

BK	<b>Matt Black</b>	RAL 9005
GG	<b>Graphite Grey</b>	RAL 7024
GM	<b>Gun Metal</b>	RAL 8019
BO	<b>Burnt Orange</b>	RAL 3022
LY	<b>Lemon Yellow</b>	RAL 1012
PP	<b>Pale Pink</b>	RAL 3015
BL	<b>Blanc</b>	RAL 9002
TT	<b>Total White</b>	RAL 9003
MI	<b>Mint</b>	RAL 6019
FO	<b>Forest</b>	RAL 6009
CB	<b>Capri Blue</b>	RAL 5019
GN	<b>Grey Navy</b>	RAL 5008

*Any RAL Classic colours are available plus 35% to prices above. For both RAL and Glass Option together please add 65% to prices above.*



**FXSBDBL**  
Return panel Support Bar  
2000 mm

*\*\*Included\*\**

## Metalwork Design layout



## Shower Door with Inline & Return Panel Configurations

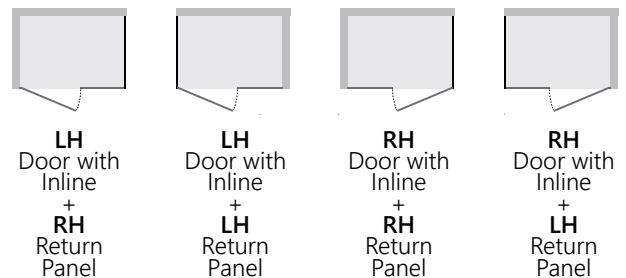

## Glass Options available

Please NOTE other Glass options are available plus additional surcharge to prices listed above.

Plus 45% additional		Plus 35% additional	
	<b>Cross Fluted</b> 8.8 mm TGH Laminated		<b>Fluted</b> 8.8 mm TGH Laminated
	<b>Frosted</b> 8 mm TGH Satin Etch		<b>Grey Tinted</b> 8 mm TGH Smoked glass

# Shower Door hinged to Inline panel



LH  
Left Hand

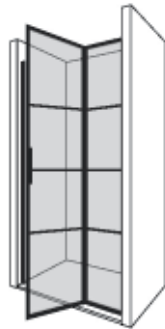

RH  
Right Hand

Shower Door is hinged to the Inline panel closing onto the wall. Left or Right hand options are available.

Doors are built using our **pivot hinge**. The 5 mm rise and fall mechanism is manufactured using zinc die castings which give a durable and strong door performance. The **magnetic closing** creates a secure seal after the shower door is closed.

**Pull handle, fixings and sealing components are included in prices below.**

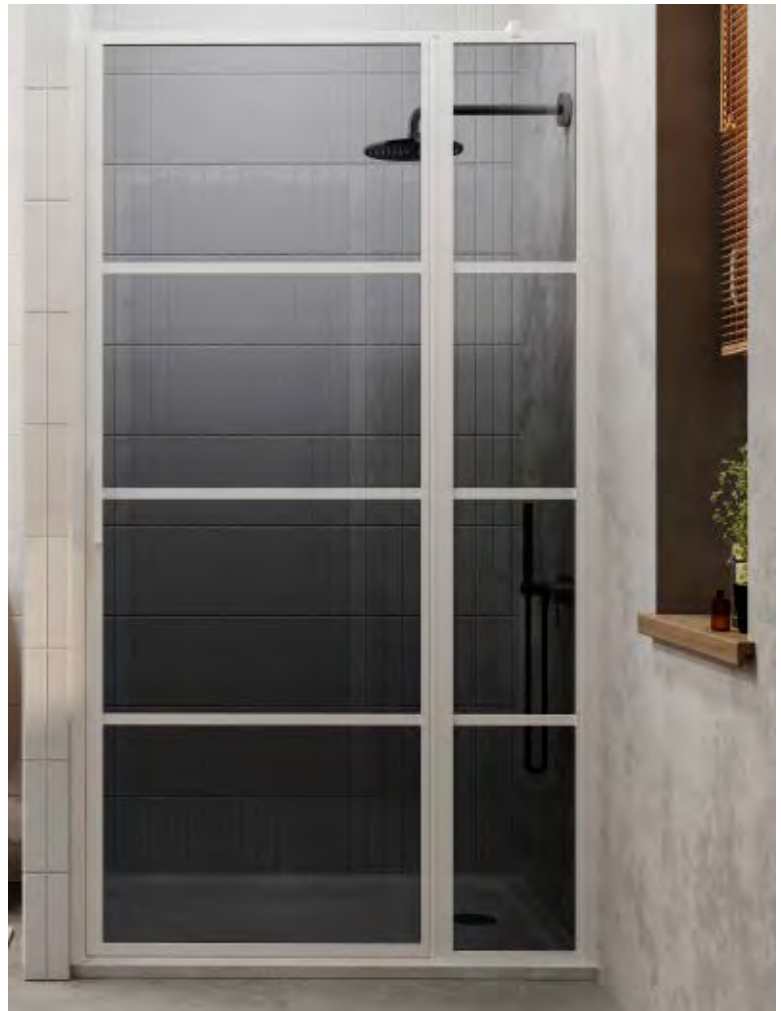

Item Code	Description	Adjustment Range	Adjustment Range	Retail Price Exc VAT (Clear Glass)
		In a recess	With Return Panel	
DECDH70/20L.. DECDH70/20R..	Door hinged to Inline <b>900 x 2100 mm</b> (700 mm Door + 200 mm Inline Panel) L Left Hand / R Right Hand <i>**FXSBPRL - Parallel Support Bar included **</i>	869 - 899 mm	875 - 890 mm	£1,223
DECDH70/30L.. DECDH70/30R..	Door hinged to Inline <b>1000 x 2100 mm</b> (700 mm Door + 300 mm Inline Panel) L Left Hand / R Right Hand <i>**FXSBPRL - Parallel Support Bar included **</i>	969 - 999 mm	975 - 990 mm	£1,350
DECDH90/30L.. DECDH90/30R..	Door hinged to Inline <b>1200 x 2100 mm</b> (900 mm Door + 300 mm Inline Panel) L Left Hand / R Right Hand <i>**FXSBPRL - Parallel Support Bar included **</i>	1169 - 1199 mm	1175 - 1190 mm	£1,585
DECDH70/70L.. DECDH70/70R..	Door hinged to Inline <b>1400 x 2100 mm</b> (700 mm Door + 700 mm Inline Panel) L Left Hand / R Right Hand <i>**FXSBPRL - Parallel Support Bar included **</i>	1369 - 1399 mm	1375 - 1390 mm	£1,915
DECDH90/60L.. DECDH90/60R..	Door hinged to Inline <b>1500 x 2100 mm</b> (900 mm Door + 600 mm Inline Panel) L Left Hand / R Right Hand <i>**FXSBPRL - Parallel Support Bar included **</i>	1469 - 1499 mm	1475 - 1490 mm	£2,033
DECDH90/70L.. DECDH90/70R..	Door hinged to Inline <b>1600 x 2100 mm</b> (900 mm Door + 700 mm Inline Panel) L Left Hand / R Right Hand <i>**FXSBPRL - Parallel Support Bar included **</i>	1569 - 1599 mm	1575 - 1590 mm	£2,254

All of our shower doors are Opening OUT, please contact us if Opening INWARDS is required. Please choose your codes depending on width required and add the two letter colour code to it.

**NOTE This item is Handed so Left or Right Hand need to be specified.**

## Metalwork Design layout

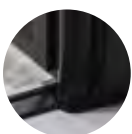

### Pivot hinge

Our Pivot hinge system with a 5 mm rise and fall mechanism. **Pivot swing can be set from 0 to 180 degree position.**



### PHAND

Minimalistic pull handle. Mechanically fixed to Closing Post.



### FXSBPRL

Parallel Support Bar 2000 mm  
(To be trimmed on site)



900



1000



1200



1400



1500

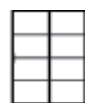

1600

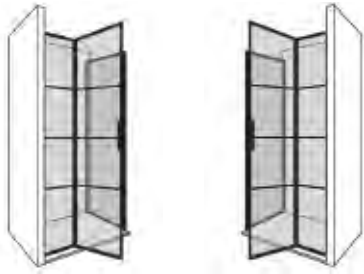

# Return Panels for Shower Door hinged to Inline Enclosures



Shower doors hinged to inline panel may be paired with a range of Return/Side Panels to create shower cubicles.

**Return panels must be ordered with the door.** If you want to create a Shower Enclosure please follow the steps below:

**1. Choose your Door hinged to Inline size,** handing, colour and glass option and keep the code.

**2. Choose the Return size,** check the hand required and keep the code.

*\*\*Our handing is based on the wall fixing position when you look at it from the outside.\*\**

**3. Specify both codes** on your order and DRENCH will make sure the correct Shower cubicle is delivered including wall fixings, handle and Support bars required.

Item Code	Description	Adjustment Range	Retail Price Exc VAT (Clear Glass)
+DEC70L.. +DEC70R..	Return Panel <b>700 x 2100 mm</b> L Left Hand / R Right Hand <i>**FXSBDBL - Return Panel Support Bar**</i>	675 - 690 mm	£801
+DEC80L.. +DEC80R..	Return Panel <b>800 x 2100 mm</b> L Left Hand / R Right Hand <i>**FXSBDBL - Return Panel Support Bar**</i>	775 - 780 mm	£836
+DEC90L.. +DEC90R..	Return Panel <b>900 x 2100 mm</b> L Left Hand / R Right Hand <i>**FXSBDBL - Return Panel Support Bar**</i>	875 - 890 mm	£859
+DEC100L.. +DEC100R..	Return Panel <b>1000 x 2100 mm</b> L Left Hand / R Right Hand <i>**FXSBDBL - Return Panel Support Bar**</i>	975 - 990 mm	£922

*For dimensions that do not fit our Standard range please contact us, We are experts on Bespoke and made to measure projects. Please email us at [sales@drenchshowers.co.uk](mailto:sales@drenchshowers.co.uk).*

## MATTE Colours available

BK	<b>Matt Black</b>	RAL 9005
GG	<b>Graphite Grey</b>	RAL 7024
GM	<b>Gun Metal</b>	RAL 8019
BO	<b>Burnt Orange</b>	RAL 3022
LY	<b>Lemon Yellow</b>	RAL 1012
PP	<b>Pale Pink</b>	RAL 3015
BL	<b>Blanc</b>	RAL 9002
TT	<b>Total White</b>	RAL 9003
MI	<b>Mint</b>	RAL 6019
FO	<b>Forest</b>	RAL 6009
CB	<b>Capri Blue</b>	RAL 5019
GN	<b>Grey Navy</b>	RAL 5008



**FXSBDBL**  
Return panel Support Bar  
2000 mm

*\*\*Included\*\**

## Metalwork Design layout



## Shower Door with Inline & Return Panel Configurations

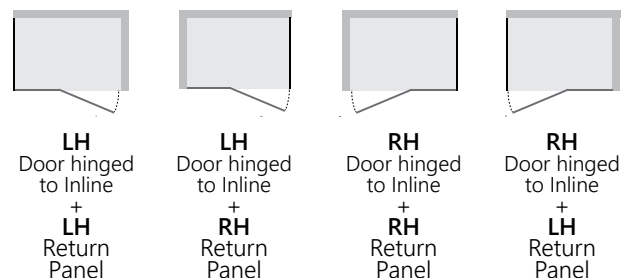

## Glass Options available

Please NOTE other Glass options are available plus additional surcharge to prices listed above.

Plus 45% additional		Plus 35% additional	
	<b>Cross Fluted</b> 8.8 mm TGH Laminated		<b>Fluted</b> 8.8 mm TGH Laminated
	<b>Frosted</b> 8 mm TGH Satin Etch		<b>Grey Tinted</b> 8 mm TGH Smoked glass

*Any RAL Classic colours are available plus 35% to prices above. For both RAL and Glass Option together please add 65% to prices above.*

# Single Shower Doors



**DECO**  
Metallic Finishes



**LH**  
Left Hand



**RH**  
Right Hand

Single doors are suitable for shower recesses. **Left** or **Right** hand options are available.

Doors are built using our **vintage butt hinges**. Each door includes 4 hinges equally positioned and recessed on profiles. The **magnetic closing** creates a secure seal after the shower door is closed.

**Pull handle, fixings and door seal are included in the price below.**



Item Code	Description	Adjustment Range		Retail Price Exc VAT (Clear Glass)
		In a recess	With Return Panel	
DECDOR70L.. DECDOR70R..	Shower Door <b>700 x 2100 mm</b> , L Left Hand / R Right Hand	671 - 689 mm	681 - 690 mm	£1,453
DECDOR76L.. DECDOR76R..	Shower Door <b>760 x 2100 mm</b> , L Left Hand / R Right Hand	721 - 739 mm	739 - 747 mm	£1,499
DECDOR80L.. DECDOR80R..	Shower Door <b>800 x 2100 mm</b> , L Left Hand / R Right Hand	771 - 789 mm	781 - 790 mm	£1,726
DECDOR90L.. DECDOR90R..	Shower Door <b>900 x 2100 mm</b> , L Left Hand / R Right Hand	871 - 889 mm	881 - 890 mm	£1,841

Please choose your codes depending on width required and add the two letter colour code to it.

**NOTE This item is Handed so Left or Right Hand need to be specified.**



**Butt Hinge**

Vintage butt hinges. Each door included 4 hinges equally positioned and recessed on profiles.



**SPHAND**

Shaped pull handle. Mechanically fixed to Closing Post.



**FXSBCRS**

Across Support Bar 1000 mm

**\*\*When Door paired with Return Panel\*\***

**Metalwork Design layout**



# Return Panels for Shower Doors Enclosures



Shower doors may be paired with a range of Return/Side Panels to create Shower Cubicles. Return panels must be ordered with the door.  
If you want to create a Shower Enclosure please follow the steps below:





1. Choose your Door size, handing, colour and glass option and keep the code.
2. Choose the Return size check the hand required and keep the code. Our handing is based on the wall fixing position when you look at it from the outside.
3. Specify both codes on your order and DRENCH will make sure the correct Shower cubicle is delivered including wall fixings, handle and Support bars required.

Item Code	Description	Adjustment Range	Retail Price Exc VAT (Clear Glass)
+DEC70L.. +DEC70R..	Return Panel <b>700 x 2100 mm</b> L Left Hand / R Right Hand <i>**FXSBCRS - Across Support Bar**</i>	675 - 690 mm	£980
+DEC80L.. +DEC80R..	Return Panel <b>800 x 2100 mm</b> L Left Hand / R Right Hand <i>**FXSBCRS - Across Support Bar**</i>	775 - 780 mm	£1,027
+DEC90L.. +DEC90R..	Return Panel <b>900 x 2100 mm</b> L Left Hand / R Right Hand <i>**FXSBCRS - Across Support Bar**</i>	875 - 890 mm	£1,073
+DEC100L.. +DEC100R..	Return Panel <b>1000 x 2100 mm</b> L Left Hand / R Right Hand <i>**FXSBCRS - Across Support Bar**</i>	975 - 990 mm	£1,150

For dimensions that do not fit our Standard range please contact us, We are experts on Bespoke and made to measure projects. Please email us at [sales@drenchshowers.co.uk](mailto:sales@drenchshowers.co.uk).

## Metalwork Design layout

### Metallic Finishes available

	LB	<b>Light Bronze</b>	Anodised
	DB	<b>Dark Bronze</b>	Anodised
	BS	<b>Brushed Steel</b>	Anodised
	BB	<b>Brushed Brass</b>	Anodised





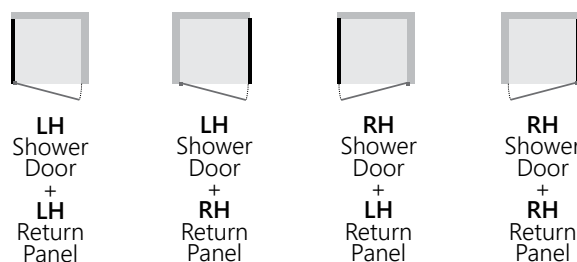

### Shower Door with Return Panel Configurations



### Glass Options available

Please NOTE other Glass options are available plus additional surcharge to prices listed above.

Plus 45% additional		Plus 35% additional	
	<b>Cross Fluted</b> 8.8 mm TGH Laminated		<b>Fluted</b> 8.8 mm TGH Laminated
	<b>Frosted</b> 8 mm TGH Satin Etch		<b>Grey Tinted</b> 8 mm TGH Smoked glass

# Shower Door with Inline panel



**DECO**  
Metallic Finishes



**LH**  
Left Hand

**RH**  
Right Hand

Door is hinged to the wall closing onto an Inline panel. Left or Right hand options are available.

Doors are built using 4 vintage ball bearing hinges finished in the metal chosen. The magnetic closing creates a secure seal after the shower door is closed.

Pull handle, fixings and door seal are included in the price below.



Item Code	Description	Adjustment Range	Adjustment Range	Retail Price Exc VAT (Clear Glass)
		In a recess	With Return Panel	
DECDI70/20L.. DECDI70/20R..	Door with Inline <b>900 x 2100 mm</b> (700 mm Door + 200 mm Inline Panel) L Left Hand / R Right Hand <i>**FXSBPRL - Parallel Support Bar included **</i>	871 - 889 mm	881 - 890 mm	£2,100
DECDI70/30L.. DECDI70/30R..	Door with Inline <b>1000 x 2100 mm</b> (700 mm Door + 300 mm Inline Panel) L Left Hand / R Right Hand <i>**FXSBPRL - Parallel Support Bar included **</i>	971 - 989 mm	981 - 990 mm	£2,179
DECDI90/30L.. DECDI90/30R..	Door with Inline <b>1200 x 2100 mm</b> (900 mm Door + 300 mm Inline Panel) L Left Hand / R Right Hand <i>**FXSBPRL - Parallel Support Bar included **</i>	1171 - 1189 mm	1181 - 1190 mm	£2,339
DECDI70/70L.. DECDI70/70R..	Door with Inline <b>1400 x 2100 mm</b> (700 mm Door + 700 mm Inline Panel) L Left Hand / R Right Hand <i>**FXSBPRL - Parallel Support Bar included **</i>	1371 - 1389 mm	1381 - 1390 mm	£2,499
DECDI90/60L.. DECDI90/60R..	Door with Inline <b>1500 x 2100 mm</b> (900 mm Door + 600 mm Inline Panel) L Left Hand / R Right Hand <i>**FXSBPRL - Parallel Support Bar included **</i>	1471 - 1489 mm	1481 - 1490 mm	£2,575
DECDI90/70L.. DECDI90/70R..	Door with Inline <b>1600 x 2100 mm</b> (900 mm Door + 700 mm Inline Panel) L Left Hand / R Right Hand <i>**FXSBPRL - Parallel Support Bar included **</i>	1571 - 1589 mm	1581 - 1590 mm	£2,644

All of our shower doors are Opening OUT, please contact us if Opening INWARDS is required.  
Please choose your codes depending on width required and add the two letter colour code to it.  
**NOTE This item is Handed so Left or Right Hand need to be specified.**

## Metalwork Design layout



**Butt Hinge**

Vintage butt hinges. Each door included 4 hinges equally positioned and recessed on profiles.



**SPHAND**

Shaped pull handle. Mechanically fixed to Closing Post.



**FXSBPRL**

Parallel Support Bar 2000 mm  
(To be trimmed on site)

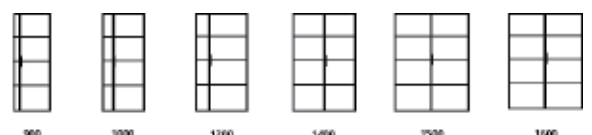



# Return Panels for Shower Door with Inline Enclosures



Shower doors with inline panel may be paired with a range of Return/Side Panels to create shower cubicles. **Return panels must be ordered with the door.** If you want to create a Shower Enclosure please follow the steps below:

**1. Choose your Door with Inline size,** handing, colour and glass option and keep the code.

**2. Choose the Return size,** check the hand required and keep the code.

*\*\*Our handing is based on the wall fixing position when you look at it from the outside.\*\**

**3. Specify both codes** on your order and DRENCH will make sure the correct Shower cubicle is delivered including wall fixings, handle and Support bars required.

Item Code	Description	Adjustment Range	Retail Price Exc VAT (Clear Glass)
+DEC70L.. +DEC70R..	Return Panel <b>700 x 2100 mm</b> L Left Hand / R Right Hand <i>**FXSBDBL - Return Panel Support Bar**</i>	675 - 690 mm	£980
+DEC80L.. +DEC80R..	Return Panel <b>800 x 2100 mm</b> L Left Hand / R Right Hand <i>**FXSBDBL - Return Panel Support Bar**</i>	775 - 780 mm	£1,027
+DEC90L.. +DEC90R..	Return Panel <b>900 x 2100 mm</b> L Left Hand / R Right Hand <i>**FXSBDBL - Return Panel Support Bar**</i>	875 - 890 mm	£1,073
+DEC100L.. +DEC100R..	Return Panel <b>1000 x 2100 mm</b> L Left Hand / R Right Hand <i>**FXSBDBL - Return Panel Support Bar**</i>	975 - 990 mm	£1,150

*For dimensions that do not fit our Standard range please contact us, We are experts on Bespoke and made to measure projects. Please email us at [sales@drenchshowers.co.uk](mailto:sales@drenchshowers.co.uk).*

## Metallic Finishes available

	LB	<b>Light Bronze</b>	Anodised
	DB	<b>Dark Bronze</b>	Anodised
	BS	<b>Brushed Steel</b>	Anodised
	BB	<b>Brushed Brass</b>	Anodised



**FXSBDBL**  
Return panel Support Bar  
2000 mm

*\*\*Included\*\**

## Metalwork Design layout



## Shower Door with Inline & Return Panel Configurations

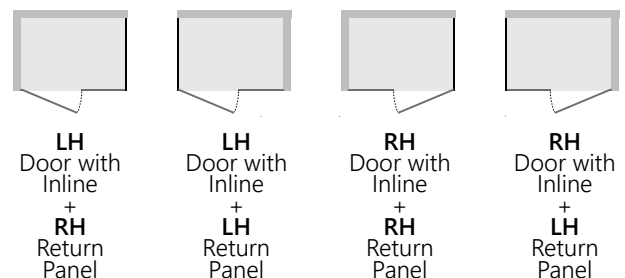

## Glass Options available

Please NOTE other Glass options are available plus additional surcharge to prices listed above.

Plus 45% additional		Plus 35% additional	
	<b>Cross Fluted</b> 8.8 mm TGH Laminated		<b>Fluted</b> 8.8 mm TGH Laminated
	<b>Frosted</b> 8 mm TGH Satin Etch		<b>Grey Tinted</b> 8 mm TGH Smoked glass

*Any RAL Classic colours are available plus 35% to prices above. For both RAL and Glass Option together please add 65% to prices above.*

# Shower Door hinged to Inline panel



**LH**  
Left Hand



**RH**  
Right Hand

Shower Door is hinged to the Inline panel closing onto the wall. Left or Right hand options are available.

Doors are built using 4 vintage ball bearing hinges finished in the metal chosen. The magnetic closing creates a secure seal after the shower door is closed.

Pull handle, fixings and door seal are included in the price below.



Item Code	Description	Adjustment Range	Adjustment Range	Retail Price Exc VAT (Clear Glass)
		In a recess	With Return Panel	
DECDH70/20L.. DECDH70/20R..	Door hinged to Inline <b>900 x 2100 mm</b> (700 mm Door + 200 mm Inline Panel) L Left Hand / R Right Hand <i>**FXSBPRL - Parallel Support Bar included **</i>	871 - 889 mm	875 - 890 mm	£2,100
DECDH70/30L.. DECDH70/30R..	Door hinged to Inline <b>1000 x 2100 mm</b> (700 mm Door + 300 mm Inline Panel) L Left Hand / R Right Hand <i>**FXSBPRL - Parallel Support Bar included **</i>	971 - 989 mm	975 - 990 mm	£2,179
DECDH90/30L.. DECDH90/30R..	Door hinged to Inline <b>1200 x 2100 mm</b> (900 mm Door + 300 mm Inline Panel) L Left Hand / R Right Hand <i>**FXSBPRL - Parallel Support Bar included **</i>	1171 - 1189 mm	1175 - 1190 mm	£2,339
DECDH70/70L.. DECDH70/70R..	Door hinged to Inline <b>1400 x 2100 mm</b> (700 mm Door + 700 mm Inline Panel) L Left Hand / R Right Hand <i>**FXSBPRL - Parallel Support Bar included **</i>	1371 - 1389 mm	1375 - 1390 mm	£2,499
DECDH90/60L.. DECDH90/60R..	Door hinged to Inline <b>1500 x 2100 mm</b> (900 mm Door + 600 mm Inline Panel) L Left Hand / R Right Hand <i>**FXSBPRL - Parallel Support Bar included **</i>	1471 - 1489 mm	1475 - 1490 mm	£2,575
DECDH90/70L.. DECDH90/70R..	Door hinged to Inline <b>1600 x 2100 mm</b> (900 mm Door + 700 mm Inline Panel) L Left Hand / R Right Hand <i>**FXSBPRL - Parallel Support Bar included **</i>	1571 - 1589 mm	1575 - 1590 mm	£2,644

All of our shower doors are Opening OUT, please contact us if Opening INWARDS is required. Please choose your codes depending on width required and add the two letter colour code to it.

**NOTE** This item is Handed so Left or Right Hand need to be specified.

## Metalwork Design layout



**Butt Hinge**

Vintage butt hinges. Each door included 4 hinges equally positioned and recessed on profiles.



**SPHAND**

Shaped pull handle. Mechanically fixed to Closing Post.



**FXSBPRL**

Parallel Support Bar 2000 mm (To be trimmed on site)

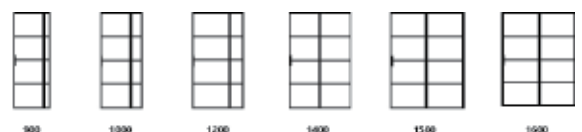



# Return Panels for Shower Door hinged to Inline Enclosures



Shower doors hinged to inline panel may be paired with a range of Return/Side Panels to create shower cubicles.

**Return panels must be ordered with the door.** If you want to create a Shower Enclosure please follow the steps below:

**1. Choose your Door hinged to Inline size,** handing, colour and glass option and keep the code.

**2. Choose the Return size,** check the hand required and keep the code.

*\*\*Our handing is based on the wall fixing position when you look at it from the outside.\*\**

**3. Specify both codes** on your order and DRENCH will make sure the correct Shower cubicle is delivered including wall fixings, handle and Support bars required.

Item Code	Description	Adjustment Range	Retail Price Exc VAT (Clear Glass)
+DEC70L.. +DEC70R..	Return Panel <b>700 x 2100 mm</b> L Left Hand / R Right Hand <i>**FXSBDBL - Return Panel Support Bar**</i>	675 - 690 mm	£980
+DEC80L.. +DEC80R..	Return Panel <b>800 x 2100 mm</b> L Left Hand / R Right Hand <i>**FXSBDBL - Return Panel Support Bar**</i>	775 - 780 mm	£1,027
+DEC90L.. +DEC90R..	Return Panel <b>900 x 2100 mm</b> L Left Hand / R Right Hand <i>**FXSBDBL - Return Panel Support Bar**</i>	875 - 890 mm	£1,073
+DEC100L.. +DEC100R..	Return Panel <b>1000 x 2100 mm</b> L Left Hand / R Right Hand <i>**FXSBDBL - Return Panel Support Bar**</i>	975 - 990 mm	£1,150

*For dimensions that do not fit our Standard range please contact us, We are experts on Bespoke and made to measure projects. Please email us at [sales@drenchshowers.co.uk](mailto:sales@drenchshowers.co.uk).*

## Metallic Finishes available

	LB	<b>Light Bronze</b>	Anodised
	DB	<b>Dark Bronze</b>	Anodised
	BS	<b>Brushed Steel</b>	Anodised
	BB	<b>Brushed Brass</b>	Anodised



**FXSBDBL**  
Return panel Support Bar  
2000 mm

*\*\*Included\*\**

## Metalwork Design layout



## Shower Door with Inline & Return Panel Configurations

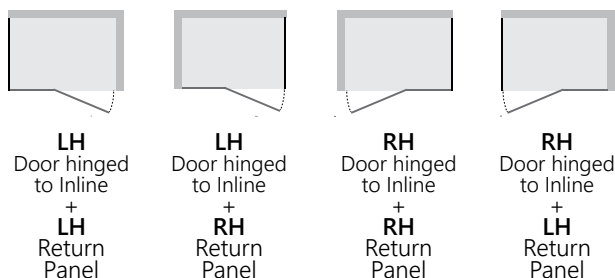

## Glass Options available

Please NOTE other Glass options are available plus additional surcharge to prices listed above.

Plus 45% additional		Plus 35% additional	
	<b>Cross Fluted</b> 8.8 mm TGH Laminated		<b>Fluted</b> 8.8 mm TGH Laminated
	<b>Frosted</b> 8 mm TGH Satin Etch		<b>Grey Tinted</b> 8 mm TGH Smoked glass

*Any RAL Classic colours are available plus 35% to prices above. For both RAL and Glass Option together please add 65% to prices above.*



*Single Shower Door 900 x 2100 closing into Return panel 900 x 2100 mm  
Brushed Brass, Fluted Glass*



**BORDER**  
Collection





# BORDER Collection

## FEATURES:

*ALL Product configurations*

*2100 mm Height*

*19 mm of Adjustment*

*12 MATTE Colours & 4 Metallic Finishes*

*8 mm Toughened Glass*

*(Fluted, Frosted, Grey Tinted & Clear Glass options)*

*Easy Clean Coating*

The Border Collection is minimal yet impactful. Plain glass contrasts a bold sleek exterior frame. Simplicity, Elegance and Design.

The most versatile and timeless style within our collections.

BORDER collection is available for all DRENCH ranges including Panels, Bath Screens, Shower Doors & Shower Enclosures..

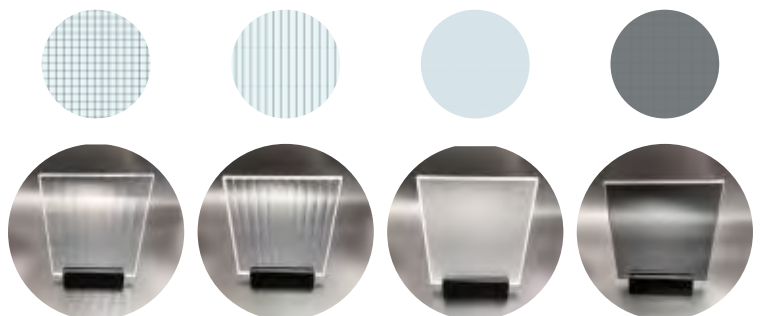
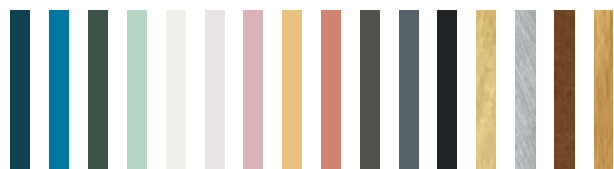

**Cross Fluted**

8.8 mm TGH  
Laminated

**Fluted**

8.8 mm TGH  
Laminated

**Frosted**

8 mm TGH  
Satin Etch









**Grey Tinted**

8 mm TGH  
Smoked glass

**Product Configurations Available**



**Standard Dimensions Vs Product Configuration**

	300	400	500	600	700	800	900	1000	1200	1400	1500	1600
 <b>Wall Fixed Panels</b> Standard Height 2100 mm											×	×
 <b>Wall Fixed Panels with Flipper Panel</b> Standard Height 2100 mm											×	×
 <b>Free Standing Panels</b> Standard Height 2100 mm	×	×	×	×	×						×	×
 <b>Single Shower Doors</b> Standard Height 2100 mm	×	×	×	×				×	×	×	×	×
 <b>Shower Doors with Inline Panel</b> Standard Height 2100 mm	×	×	×	×	×	×						
 <b>Shower Doors hinged to Inline Panel</b> Standard Height 2100 mm	×	×	×	×	×	×						
 <b>Return Panels for Shower Enclosures</b> Standard Height 2100 mm	×	×	×	×					×	×	×	×
 <b>Bath Screens (Pivot &amp; Fixed)</b> Standard Height 1500 mm	×	×	×	×	×		×	×	×	×	×	×



## Wall Fixed Panels

Panel is attached to the Wall using Wall Channel and Support Bar.

# MATTE Colours



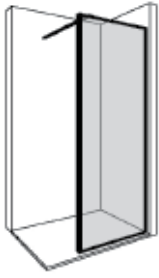

# BORDER MATTE Colours

## Wall Fixed Panels

Please choose your codes depending on width required and add the two letter colour code to it. Prices below are RRP exc VAT for CLEAR GLASS, other GLASS OPTIONS are available plus additional surcharge.

Item Code	Description	Adjustment Range	Retail Price Exc VAT (Clear Glass)
FXBOR30..	Fixed Panel <b>300 mm x 2100 mm</b> <i>**No support Bar Included**</i>	275 - 290 mm	£611
FXBOR40..	Fixed Panel <b>400 mm x 2100 mm</b> <i>**No support Bar Included**</i>	375 - 390 mm	£646
FXBOR50..	Fixed Panel <b>500 mm x 2100 mm</b> <i>**FXSBNGL - Angle Support Bar**</i>	475 - 490 mm	£688
FXBOR60..	Fixed Panel <b>600 mm x 2100 mm</b> <i>**FXSBNGL - Angle Support Bar**</i>	575 - 590 mm	£725
FXBOR70..	Fixed Panel <b>700 mm x 2100 mm</b> <i>**FXSBNGL - Angle Support Bar**</i>	675 - 690 mm	£777
FXBOR80..	Fixed Panel <b>800 mm x 2100 mm</b> <i>**FXSBCRS - Across Support Bar**</i>	775 - 790 mm	£918
FXBOR90..	Fixed Panel <b>900 mm x 2100 mm</b> <i>**FXSBCRS - Across Support Bar**</i>	875 - 890 mm	£962
FXBOR100..	Fixed Panel <b>1000 mm x 2100 mm</b> <i>**FXSBCRS - Across Support Bar**</i>	975 - 990 mm	£1.007
FXBOR120..	Fixed Panel <b>1200 mm x 2100 mm</b> <i>**FXSBCRS - Across Support Bar**</i>	1175 - 1190 mm	£1.099
FXBOR140..	Fixed Panel <b>1400 mm x 2100 mm</b> <i>**FXSBCRS - Across Support Bar**</i>	1375 - 1390 mm	£1.192

Please NOTE Support bars are included on price as per Product descriptions. For dimensions that do not fit our Standard range please contact us, we are experts on Bespoke and made to measure projects. Please email us at [sales@drenchshowers.co.uk](mailto:sales@drenchshowers.co.uk).

### MATTE Colours available

BK	<b>Matt Black</b>	RAL 9005
GG	<b>Graphite Grey</b>	RAL 7024
GM	<b>Gun Metal</b>	RAL 8019
BO	<b>Burnt Orange</b>	RAL 3022
LY	<b>Lemon Yellow</b>	RAL 1012
PP	<b>Pale Pink</b>	RAL 3015
BL	<b>Blanc</b>	RAL 9002
TT	<b>Total White</b>	RAL 9003
MI	<b>Mint</b>	RAL 6019
FO	<b>Forest</b>	RAL 6009
CB	<b>Capri Blue</b>	RAL 5019
GN	<b>Grey Navy</b>	RAL 5008

Any RAL Classic colours are available **plus 35% to prices above**. For both RAL and Glass Option together please add **65% to prices above**.

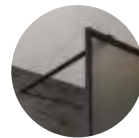

**FXSBCRS**  
Across Support Bar  
1000 mm



**FXSBNGL**  
Angle Support Bar  
450 mm

### Metalwork Design layout

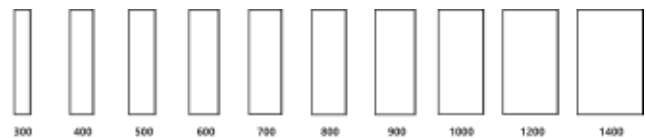

### Glass Options available

Please NOTE other Glass options are available plus additional surcharge to prices listed above.

Plus 45% additional

Plus 35% additional

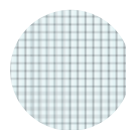

**Cross Fluted**  
8.8 mm TGH  
Laminated



**Fluted**  
8.8 mm TGH  
Laminated



**Frosted**  
8 mm TGH  
Satin Etch

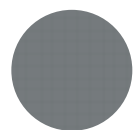

**Grey Tinted**  
8 mm TGH  
Smoked glass



## Fixed Panels with Flipper Panel

**Flipper panel is delivered already assembled to the fixed panel.**

It cannot be installed retrospectively. The pivot mechanism is adjustable from 0 to 180 degree position.

# MATTE Colours



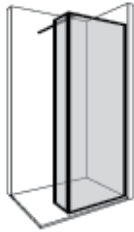

# BORDER MATTE Colours

## Fixed Panels with Flipper

Please choose your codes depending on width required and add the two letter colour code to it.  
**NOTE This item is Handed so Left or Right Hand need to be specified.**



LH  
Left Hand



RH  
Right Hand

Item Code	Description	Adjustment Range	Retail Price Exc VAT (Clear Glass)
FXBOR30FLIPL.. FXBOR30FLIPR..	Fixed Panel <b>300 x 2100 mm with 300 Flipper.</b> R: Right Hand wall fixing / L: Left Hand wall fixing **FXSBNGL - Angle Support Bar**	580 - 590 mm	£940
FXBOR40FLIPL.. FXBOR40FLIPR..	Fixed Panel <b>400 x 2100 mm with 300 Flipper.</b> R: Right Hand wall fixing / L: Left Hand wall fixing **FXSBNGL - Angle Support Bar**	680 - 690 mm	£981
FXBOR50FLIPL.. FXBOR50FLIPR..	Fixed Panel <b>500 x 2100 mm with 300 Flipper.</b> R: Right Hand wall fixing / L: Left Hand wall fixing **FXSBCRS - Across Support Bar**	780 - 790 mm	£1,006
FXBOR60FLIPL.. FXBOR60FLIPR..	Fixed Panel <b>600 x 2100 mm with 300 Flipper.</b> R: Right Hand wall fixing / L: Left Hand wall fixing **FXSBCRS - Across Support Bar**	880 - 890 mm	£1,060
FXBOR70FLIPL.. FXBOR70FLIPR..	Fixed Panel <b>700 x 2100 mm with 300 Flipper.</b> R: Right Hand wall fixing / L: Left Hand wall fixing **FXSBCRS - Across Support Bar**	980 - 990 mm	£1,101
FXBOR80FLIPL.. FXBOR80FLIPR..	Fixed Panel <b>800 x 2100 mm with 300 Flipper.</b> R: Right Hand wall fixing / L: Left Hand wall fixing **FXSBCRS - Across Support Bar**	1080 - 1090 mm	£1,152
FXBOR90FLIPL.. FXBOR90FLIPR..	Fixed Panel <b>900 x 2100 mm with 300 Flipper.</b> R: Right Hand wall fixing / L: Left Hand wall fixing **FXSBCRS - Across Support Bar**	1180 - 1190 mm	£1,196
FXBOR100FLIPL.. FXBOR100FLIPR..	Fixed Panel <b>1000 x 2100 mm with 300 Flipper.</b> R: Right Hand wall fixing / L: Left Hand wall fixing **FXSBCRS - Across Support Bar**	1280 - 1290 mm	£1,224
FXBOR120FLIPL.. FXBOR120FLIPR..	Fixed Panel <b>1200 x 2100 mm with 300 Flipper.</b> R: Right Hand wall fixing / L: Left Hand wall fixing **FXSBCRS - Across Support Bar**	1480 - 1490 mm	£1,309
FXBOR140FLIPL.. FXBOR140FLIPR..	Fixed Panel <b>1400 x 2100 mm with 300 Flipper.</b> R: Right Hand wall fixing / L: Left Hand wall fixing **FXSBCRS - Across Support Bar**	1680 - 1690 mm	£1,390

Please NOTE Support bars are included on price as per Product descriptions.  
 For dimensions that do not fit our Standard range please email us at [sales@drenchshowers.co.uk](mailto:sales@drenchshowers.co.uk).

### MATTE Colours available

BK	<b>Matt Black</b>	RAL 9005
GG	<b>Graphite Grey</b>	RAL 7024
GM	<b>Gun Metal</b>	RAL 8019
BO	<b>Burnt Orange</b>	RAL 3022
LY	<b>Lemon Yellow</b>	RAL 1012
PP	<b>Pale Pink</b>	RAL 3015
BL	<b>Blanc</b>	RAL 9002
TT	<b>Total White</b>	RAL 9003
MI	<b>Mint</b>	RAL 6019
FO	<b>Forest</b>	RAL 6009
CB	<b>Capri Blue</b>	RAL 5019
GN	<b>Grey Navy</b>	RAL 5008

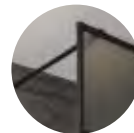

**FXSBCRS**  
Across Support Bar  
1000 mm



**FXSBNGL**  
Angle Support Bar  
450 mm

### Metalwork Design layout

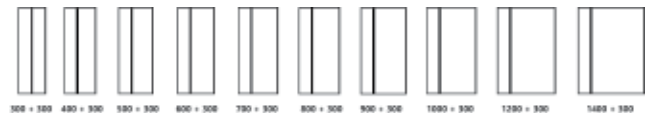

### Glass Options available

Please NOTE other Glass options are available plus additional surcharge to prices listed above.

Plus 45% additional      Plus 35% additional

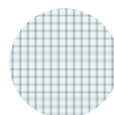

**Cross Fluted**  
8.8 mm TGH  
Laminated



**Fluted**  
8.8 mm TGH  
Laminated



**Frosted**  
8 mm TGH  
Satin Etch

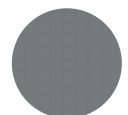

**Grey Tinted**  
8 mm TGH  
Smoked glass

Any RAL Classic colours are available **plus 35% to prices above**. For both RAL and Glass Option together please add **65% to prices above**.

# BORDER MATTE Colours

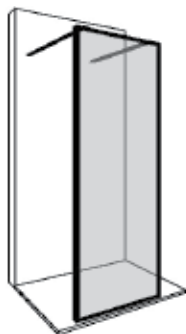

## Free Standing Panels

**Free standing Shower Screen** for Wet rooms and walk-in showers.  
2 Across Support bars included in price.

Please add the two letter colour code to your code chosen above.

Item Code	Description	Physical width of Unit	Retail Price Exc VAT (Clear Glass)
FXBOR80FST..	Free Standing Panel <b>800 mm x 2100 mm</b> **2 x FXSBCRS - Across Support Bar**	762 mm	£918
FXBOR90FST..	Free Standing Panel <b>900 mm x 2100 mm</b> **2 x FXSBCRS - Across Support Bar**	862 mm	£962
FXBOR100FST..	Free Standing Panel <b>1000 mm x 2100 mm</b> **2 x FXSBCRS - Across Support Bar**	962 mm	£1,007
FXBOR120FST..	Free Standing Panel <b>1200 mm x 2100 mm</b> **2 x FXSBCRS - Across Support Bar**	1162 mm	£1,099
FXBOR140FST..	Free Standing Panel <b>1400 mm x 2100 mm</b> **2 x FXSBCRS - Across Support Bar**	1362 mm	£1,192

Please NOTE Support bars are included on price as per Product descriptions.  
For dimensions that do not fit our Standard range please contact us, we are experts on Bespoke and made to measure projects.  
Please email us at [sales@drenchshowers.co.uk](mailto:sales@drenchshowers.co.uk).

### MATTE Colours available

	BK	<b>Matt Black</b>	RAL 9005
	GG	<b>Graphite Grey</b>	RAL 7024
	GM	<b>Gun Metal</b>	RAL 8019
	BO	<b>Burnt Orange</b>	RAL 3022
	LY	<b>Lemon Yellow</b>	RAL 1012
	PP	<b>Pale Pink</b>	RAL 3015
	BL	<b>Blanc</b>	RAL 9002
	TT	<b>Total White</b>	RAL 9003
	MI	<b>Mint</b>	RAL 6019
	FO	<b>Forest</b>	RAL 6009
	CB	<b>Capri Blue</b>	RAL 5019
	GN	<b>Grey Navy</b>	RAL 5008

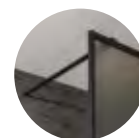

**FXSBCRS (x2)**  
Across Support Bar  
1000 mm

### Metalwork Design layout

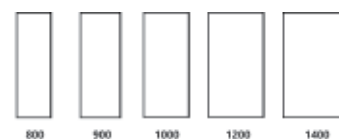

### Glass Options available

Please NOTE other Glass options are available plus additional surcharge to prices listed above.

Plus 45% additional

Plus 35% additional

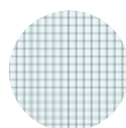

**Cross Fluted**  
8.8 mm TGH  
Laminated



**Fluted**  
8.8 mm TGH  
Laminated



**Frosted**  
8 mm TGH  
Satin Etch



**Grey Tinted**  
8 mm TGH  
Smoked glass

Any RAL Classic colours are available **plus 35% to prices above**. For both RAL and Glass Option together please add 65% to prices above.

# MATTE Colours



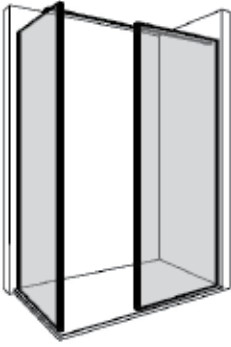

## Support Bars for Panel Combinations

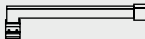

DRENCH Shower panels can be used individually or combined to recreate a walk-in shower space. When Shower panels are ordered individually support bars required for installation are included in the price and supplied by DRENCH.

When Shower Panels are combined, possibilities are endless hence we have designed a range of accessories suitable for any design or configuration.

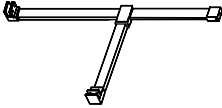
All support bars and fixings are supplied in same colour/finish as the Shower panel.

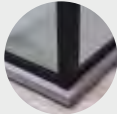
Item Code	Item Description	Specification	Retail Price Metallic Finishes (Exc VAT)
FXSBNGL..	<b>90° Angle Support Bar</b> (3 components, not pre-assembled) 450 mm length, 30 x 10 mm bar. **Not suitable for panels wider than 1000 mm**	 	£99
FXSBTBAR..	<b>T Shape Support bar</b> (4 components, not pre-assembled) 2x 30 x 10 mm bars. Long bar 1200 mm + Short bar at 1000 mm **Suitable for Shower Panels combinations**	 	£139
PR758..	<b>Corner Channel</b> for L Shape configurations Wall Fixings included. <b>2100 mm standard length</b>	 	£128

### Shower Panels Combinations Sample Layouts

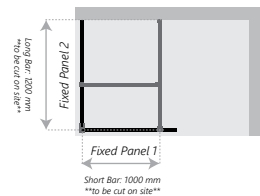
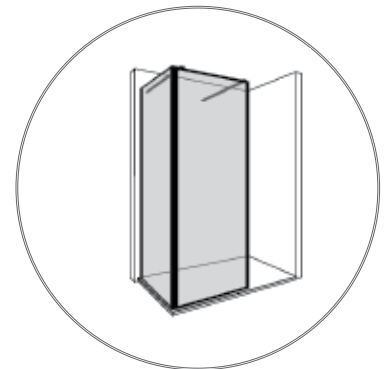
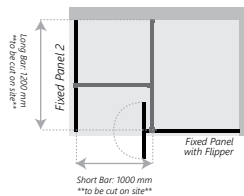
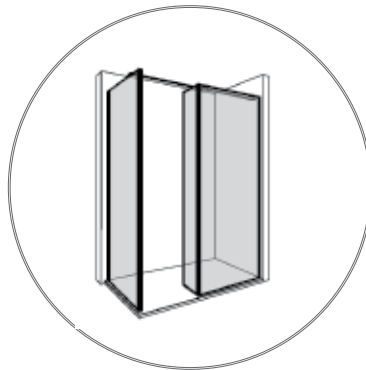
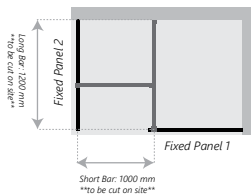
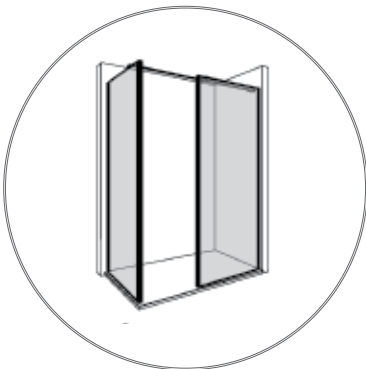

For Walk-In showers with Wall Fixed panels, **T Shape support bar (FXSBT-BAR..)** is recommended for installation purposes.

Please note the T BAR includes 2 bars at 1200 and 1000 mm. These bars can be trimmed on site to fit most of standard walk in shower dimensions.

For Walk-In showers with Wall Fixed panels and Fixed Panel with Flipper, **T Shape support bar (FXSBT-BAR..)** is recommended for installation purposes.

Please note the T BAR includes 2 bars at 1200 and 1000 mm. These bars can be trimmed on site to fit most of standard walk in shower dimensions.

For L-Shape configurations with Wall Fixed panels, **Corner channel (PR758)** and extra **T Shape support bar (FXSBT-BAR..)** is recommended for installation purposes.

Please note the T BAR includes 2 bars at 1200 and 1000 mm. These bars can be trimmed on site to fit most of standard walk in shower dimensions.



## Wall Fixed Panels

Panel is attached to the Wall using Wall Channel and Support Bar.

## Metallic Finishes





# BORDER Metallic Finishes

## Wall Fixed Panels

Please choose your codes depending on width required and add the two letter colour code to it.





Prices below are RRP exc VAT for CLEAR GLASS, other GLASS OPTIONS are available plus additional surcharge.

Item Code	Description	Adjustment Range	Retail Price Exc VAT (Clear Glass)
FXBOR30..	Fixed Panel <b>300 mm x 2100 mm</b> <i>**No support Bar Included**</i>	275 - 290 mm	£861
FXBOR40..	Fixed Panel <b>400 mm x 2100 mm</b> <i>**No support Bar Included**</i>	375 - 390 mm	£950
FXBOR50..	Fixed Panel <b>500 mm x 2100 mm</b> <b>**FXSBCRS - Across Support Bar**</b>	475 - 490 mm	£1,012
FXBOR60..	Fixed Panel <b>600 mm x 2100 mm</b> <b>**FXSBCRS - Across Support Bar**</b>	575 - 590 mm	£1,066
FXBOR70..	Fixed Panel <b>700 mm x 2100 mm</b> <b>**FXSBCRS - Across Support Bar**</b>	675 - 690 mm	£1,142
FXBOR80..	Fixed Panel <b>800 mm x 2100 mm</b> <b>**FXSBCRS - Across Support Bar**</b>	775 - 790 mm	£1,304
FXBOR90..	Fixed Panel <b>900 mm x 2100 mm</b> <b>**FXSBCRS - Across Support Bar**</b>	875 - 890 mm	£1,369
FXBOR100..	Fixed Panel <b>1000 mm x 2100 mm</b> <b>**FXSBCRS - Across Support Bar**</b>	975 - 990 mm	£1,435
FXBOR120..	Fixed Panel <b>1200 mm x 2100 mm</b> <b>**FXSBCRS - Across Support Bar**</b>	1175 - 1190 mm	£1,567
FXBOR140..	Fixed Panel <b>1400 mm x 2100 mm</b> <b>**FXSBCRS - Across Support Bar**</b>	1375 - 1390 mm	£1,702

Please NOTE Support bars are included on price as per Product descriptions. For dimensions that do not fit our Standard range please contact us, we are experts on Bespoke and made to measure projects.

Please email us at [sales@drenchshowers.co.uk](mailto:sales@drenchshowers.co.uk).

### Metallic Finishes available

	LB	<b>Light Bronze</b>	Anodised
	DB	<b>Dark Bronze</b>	Anodised
	BS	<b>Brushed Steel</b>	Anodised
	BB	<b>Brushed Brass</b>	Anodised



**FXSBCRS**  
Across Support Bar  
1000 mm

### Metalwork Design layout

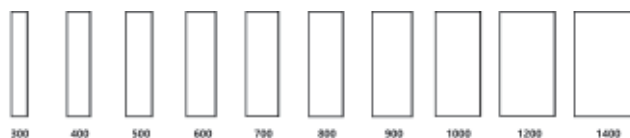

### Glass Options available

Please NOTE other Glass options are available plus additional surcharge to prices listed above.

Plus 45% additional

Plus 35% additional

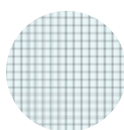

**Cross Fluted**  
8.8 mm TGH  
Laminated



**Fluted**  
8.8 mm TGH  
Laminated



**Frosted**  
8 mm TGH  
Satin Etch



**Grey Tinted**  
8 mm TGH  
Smoked glass



## Fixed Panels with Flipper Panel

**Flipper panel is delivered already assembled to the fixed panel.**

It cannot be installed retrospectively. The pivot mechanism is adjustable from 0 de to 180 degree position.

## Metallic Finishes





# BORDER Metallic Finishes

## Fixed Panels with Flipper

Please choose your codes depending on width required and add the two letter colour code to it.  
**NOTE This item is Handed so Left or Right Hand need to be specified.**



**LH**  
Left Hand



**RH**  
Right Hand

Item Code	Description	Adjustment Range	Retail Price Exc VAT (Clear Glass)
FXBOR30FLIPL.. FXBOR30FLIPR..	Fixed Panel <b>300 x 2100 mm with 300 Flipper.</b> R: Right Hand wall fixing / L: Left Hand wall fixing **FXSBCRS - Across Support Bar**	580 - 590 mm	£1,382
FXBOR40FLIPL.. FXBOR40FLIPR..	Fixed Panel <b>400 x 2100 mm with 300 Flipper.</b> R: Right Hand wall fixing / L: Left Hand wall fixing **FXSBCRS - Across Support Bar**	680 - 690 mm	£1,430
FXBOR50FLIPL.. FXBOR50FLIPR..	Fixed Panel <b>500 x 2100 mm with 300 Flipper.</b> R: Right Hand wall fixing / L: Left Hand wall fixing **FXSBCRS - Across Support Bar**	780 - 790 mm	£1,479
FXBOR60FLIPL.. FXBOR60FLIPR..	Fixed Panel <b>600 x 2100 mm with 300 Flipper.</b> R: Right Hand wall fixing / L: Left Hand wall fixing **FXSBCRS - Across Support Bar**	880 - 890 mm	£1,559
FXBOR70FLIPL.. FXBOR70FLIPR..	Fixed Panel <b>700 x 2100 mm with 300 Flipper.</b> R: Right Hand wall fixing / L: Left Hand wall fixing **FXSBCRS - Across Support Bar**	980 - 990 mm	£1,618
FXBOR80FLIPL.. FXBOR80FLIPR..	Fixed Panel <b>800 x 2100 mm with 300 Flipper.</b> R: Right Hand wall fixing / L: Left Hand wall fixing **FXSBCRS - Across Support Bar**	1080 - 1090 mm	£1,729
FXBOR90FLIPL.. FXBOR90FLIPR..	Fixed Panel <b>900 x 2100 mm with 300 Flipper.</b> R: Right Hand wall fixing / L: Left Hand wall fixing **FXSBCRS - Across Support Bar**	1180 - 1190 mm	£1,791
FXBOR100FLIPL.. FXBOR100FLIPR..	Fixed Panel <b>1000 x 2100 mm with 300 Flipper.</b> R: Right Hand wall fixing / L: Left Hand wall fixing **FXSBCRS - Across Support Bar**	1280 - 1290 mm	£1,859
FXBOR120FLIPL.. FXBOR120FLIPR..	Fixed Panel <b>1200 x 2100 mm with 300 Flipper.</b> R: Right Hand wall fixing / L: Left Hand wall fixing **FXSBCRS - Across Support Bar**	1480 - 1490 mm	£1,995
FXBOR140FLIPL.. FXBOR140FLIPR..	Fixed Panel <b>1400 x 2100 mm with 300 Flipper.</b> R: Right Hand wall fixing / L: Left Hand wall fixing **FXSBCRS - Across Support Bar**	1680 - 1690 mm	£2,118

Please NOTE Support bars are included on price as per Product descriptions.  
 For dimensions that do not fit our Standard range please email us at [sales@drenchshowers.co.uk](mailto:sales@drenchshowers.co.uk).

### Metallic Finishes available

	LB	<b>Light Bronze</b>	Anodised
	DB	<b>Dark Bronze</b>	Anodised
	BS	<b>Brushed Steel</b>	Anodised
	BB	<b>Brushed Brass</b>	Anodised



**FXSBCRS**  
Across Support Bar  
1000 mm

### Metalwork Design layout

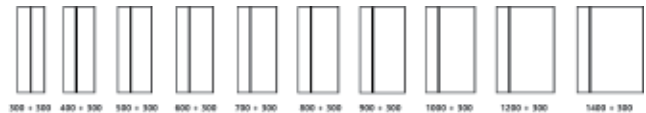

### Glass Options available

Please NOTE other Glass options are available plus additional surcharge to prices listed above.

Plus 45% additional

Plus 35% additional

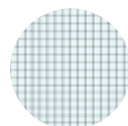

**Cross Fluted**

8.8 mm TGH  
Laminated



**Fluted**

8.8 mm TGH  
Laminated



**Frosted**

8 mm TGH  
Satin Etch



**Grey Tinted**

8 mm TGH  
Smoked glass

# BORDER Metallic Finishes



## Free Standing Panels





**Free standing Shower Screen** for Wet rooms and walk-in showers.  
2 Across Support bars included in price.

Please add the two letter colour code to your code chosen above.

Item Code	Description	Physical width of Unit	Retail Price Exc VAT (Clear Glass)
FXBOR80FST..	Free Standing Panel <b>800 mm x 2100 mm</b> **2 x FXSBCRS - Across Support Bar**	762 mm	£1,304
FXBOR90FST..	Free Standing Panel <b>900 mm x 2100 mm</b> **2 x FXSBCRS - Across Support Bar**	862 mm	£1,369
FXBOR100FST..	Free Standing Panel <b>1000 mm x 2100 mm</b> **2 x FXSBCRS - Across Support Bar**	962 mm	£1,435
FXBOR120FST..	Free Standing Panel <b>1200 mm x 2100 mm</b> **2 x FXSBCRS - Across Support Bar**	1162 mm	£1,567
FXBOR140FST..	Free Standing Panel <b>1400 mm x 2100 mm</b> **2 x FXSBCRS - Across Support Bar**	1362 mm	£1,702

Please NOTE Support bars are included on price as per Product descriptions.  
For dimensions that do not fit our Standard range please contact us, we are experts on Bespoke and made to measure projects.  
Please email us at [sales@drenchshowers.co.uk](mailto:sales@drenchshowers.co.uk).

### Metallic Finishes available

	LB	<b>Light Bronze</b>	Anodised
	DB	<b>Dark Bronze</b>	Anodised
	BS	<b>Brushed Steel</b>	Anodised
	BB	<b>Brushed Brass</b>	Anodised



**FXSBCRS**  
Across Support Bar  
1000 mm

### Metalwork Design layout

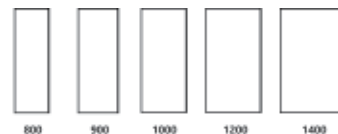

### Glass Options available

Please NOTE other Glass options are available plus additional surcharge to prices listed above.

Plus 45% additional

Plus 35% additional

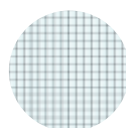

**Cross Fluted**  
8.8 mm TGH  
Laminated



**Fluted**  
8.8 mm TGH  
Laminated



**Frosted**  
8 mm TGH  
Satin Etch



**Grey Tinted**  
8 mm TGH  
Smoked glass







# Metallic Finishes

## Support Bars for Panel Combinations

DRENCH Shower panels can be used individually or combined to recreate a walk-in shower space. When Shower panels are ordered individually support bars required for installation are included in the price and supplied by DRENCH.

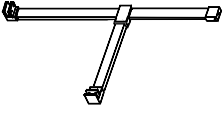
When Shower Panels are combined, possibilities are endless hence we have designed a range of accessories suitable for any design or configuration.

All support bars and fixings are supplied in same colour/finish as the Shower panel.

Item Code	Item Description	Specification	Retail Price Metallic Finishes (Exc VAT)
FXSBTBAR..	<b>T Shape Support bar</b> (4 components, not pre-assembled) 2x 30 x 10 mm bars. Long bar 1200 mm + Short bar at 1000 mm **Suitable for Shower Panels combinations**	 	<b>£235</b>
PR758..	<b>Corner Channel</b> for L Shape configurations Wall Fixings included. <b>2100 mm standard length</b>	 	<b>£213</b>

### Shower Panels Combinations Sample Layouts

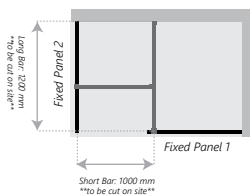

For Walk-In showers with Wall Fixed panels, **T Shape support bar (FXSBT-BAR..)** is recommended for installation purposes.

Please note the T BAR includes 2 bars at 1200 and 1000 mm.

These bars can be trimmed on site to fit most of standard walk in shower dimensions.

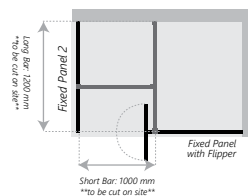

For Walk-In showers with Wall Fixed panels and Fixed Panel with Flipper, **T Shape support bar (FXSBT-BAR..)** is recommended for installation purposes.

Please note the T BAR includes 2 bars at 1200 and 1000 mm.

These bars can be trimmed on site to fit most of standard walk in shower dimensions.

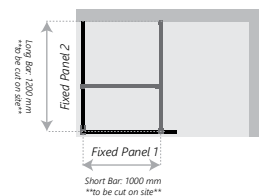
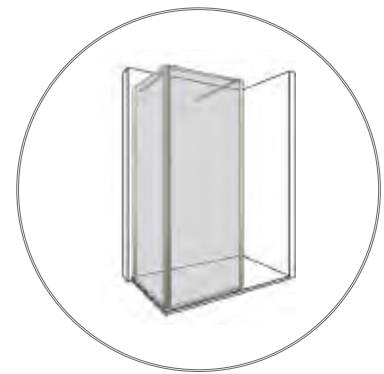

For L-Shape configurations with Wall Fixed panels, **Corner channel (PR758)** and extra **T Shape support bar (FXSBT-BAR..)** is recommended for installation purposes.

Please note the T BAR includes 2 bars at 1200 and 1000 mm.

These bars can be trimmed on site to fit most of standard walk in shower dimensions.



## Bath Screens



There is really nothing better than a nice long soak in the tub after a long and stressful day.

We love the idea we can contribute to make your bathtub look different with our range of Bath Screens.

DRENCH Bath Screens are available in pretty much all collections plus you can choose between 12 MATTE Colour options, 6 Metallic Finishes and our gorgeous glass options like Fluted, Frosted and Grey Tinted Glass.



**Fixed Bath Screen**  
Wall Fixed channel  
Included

**Fixed Bath screen** are a reduced version or our **Wall fixed** panels suitable to be installed onto a bath. This configuration ticks the box for small bathrooms.

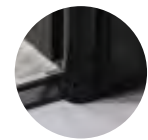

**Pivot hinged Bath Screen**

**Pivot Bath Screens** are hinged to the wall and swing **180 degrees**. Pivot bath screens are handed so make sure you choose the **Left or Right** hand code when ordering.

There is a 10 mm gap between the bottom profile and the top of the bath to allow the pivot mechanism work. A black rubber seal is supplied with the screen to cover the gap and guarantee watertight conditions.

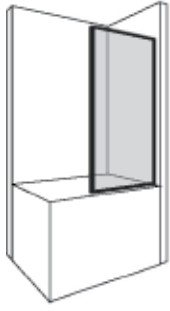

# BORDER MATTE Colours

## Bath Screens

**Both pivot and fixed bath screen options available.**  
Please add the two letter colour code to your code chosen above.

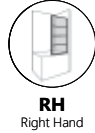
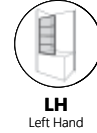

Item Code	Description	Adjustment Range	Retail Price Exc VAT (Clear Glass)
<b>BORFXBAT..</b>	Fixed Bath Screen <b>800 x 1500 mm</b>	760 - 780 mm	£628
<b>BORBATL..</b> <b>BORBATR..</b>	Pivot Hinged Bath Screen <b>800 x 1500 mm</b> L Left Hand / R Right Hand	760 - 780 mm	£645

For dimensions that do not fit our Standard range please contact us, we are experts on Bespoke and made to measure projects.  
Please email us at [sales@drenchshowers.co.uk](mailto:sales@drenchshowers.co.uk).

### MATTE Colours available

	BK	<b>Matt Black</b>	RAL9005
	GG	<b>Graphite Grey</b>	RAL7024
	GM	<b>Gun Metal</b>	RAL 8019
	BO	<b>Burnt Orange</b>	RAL 3022
	LY	<b>Lemon Yellow</b>	RAL 1012
	PP	<b>Pale Pink</b>	RAL 3015
	BL	<b>Blanc</b>	RAL 9002
	TT	<b>Total White</b>	RAL9003
	MI	<b>Mint</b>	RAL 6019
	FO	<b>Forest</b>	RAL 6009
	CB	<b>Capri Blue</b>	RAL 5019
	GN	<b>Grey Navy</b>	RAL 5008

### Metalwork Design layout



### Glass Options available

Please NOTE other Glass options are available plus additional surcharge to prices listed above.

Plus 45% additional

Plus 35% additional

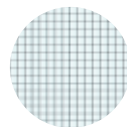

**Cross Fluted**  
8.8 mm TGH  
Laminated



**Fluted**  
8.8 mm TGH  
Laminated



**Frosted**  
8 mm TGH  
Satin Etch



**Grey Tinted**  
8 mm TGH  
Smoked glass

Any RAL Classic colours are available **plus 35% to prices above**. For both RAL and Glass Option together please add **65% to prices above**.



## Bath Screens



### BORDER Metallic Finishes

There is really nothing better than a nice long soak in the tub after a long and stressful day.

We love the idea we can contribute to make your bathtub look different with our range of Bath Screens.

DRENCH Bath Screens are available in pretty much all collections plus you can choose between 12 MATTE Colour options, 6 Metallic Finishes and our gorgeous glass options like Fluted, Frosted and Grey Tinted Glass.



**Fixed Bath Screen**  
Wall Fixed channel  
Included

**Fixed Bath screen** are a reduced version or our **Wall fixed** panels suitable to be installed onto a bath. This configuration ticks the box for small bathrooms.

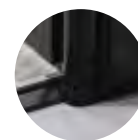

**Pivot Hinge  
Bath Screen**

**Pivot Bath Screens** are hinged to the wall and swing **180 degrees**. Pivot bath screens are handed so make sure you choose the **Left or Right** hand code when ordering.

There is a 10 mm gap between the bottom profile and the top of the bath to allow the pivot mechanism work. A black rubber seal is supplied with the screen to cover the gap and guarantee watertight conditions.



# BORDER Metallic Finishes

## Bath Screens



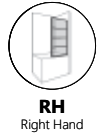
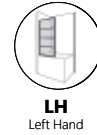

**Both pivot and fixed bath screen options available.**  
Please add the two letter colour code to your code chosen above.



Item Code	Description	Adjustment Range	Retail Price Exc VAT (Clear Glass)
<b>BORFXBAT..</b>	Fixed Bath Screen <b>800 x 1500 mm</b>	760 - 780 mm	<b>£828</b>
<b>BORBATL..</b> <b>BORBATR..</b>	Pivot Hinged Bath Screen <b>800 x 1500 mm</b> L Left Hand / R Right Hand	760 - 780 mm	<b>£914</b>

For dimensions that do not fit our Standard range please contact us, we are experts on Bespoke and made to measure projects.  
Please email us at [sales@drenchshowers.co.uk](mailto:sales@drenchshowers.co.uk).

### Metallic Finishes available

	LB	<b>Light Bronze</b>	Anodised
	DB	<b>Dark Bronze</b>	Anodised
	BS	<b>Brushed Steel</b>	Anodised
	BB	<b>Brushed Brass</b>	Anodised

### Metalwork Design layout



### Glass Options available

Please NOTE other Glass options are available plus additional surcharge to prices listed above.

Plus 45% additional

Plus 35% additional

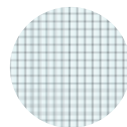

**Cross Fluted**  
8.8 mm TGH  
Laminated



**Fluted**  
8.8 mm TGH  
Laminated



**Frosted**  
8 mm TGH  
Satin Etch



**Grey Tinted**  
8 mm TGH  
Smoked glass

# Single Shower Doors

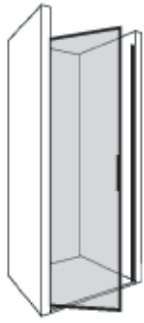

**LH**  
Left Hand

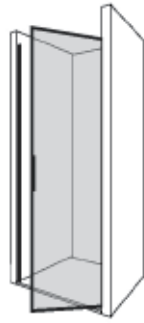

**RH**  
Right Hand

Single doors are suitable for shower recesses. **Left** or **Right** hand options are available.

Doors are built using our **pivot hinge**. The 5 mm rise and fall mechanism is manufactured using zinc die castings which give a durable and strong door performance. The **magnetic closing** creates a secure seal after the shower door is closed.

**Pull handle, fixings and door seal are included in the price below.**



Item Code	Description	Adjustment Range		Retail Price Exc VAT (Clear Glass)
		In a recess	With Return Panel	
BORDOR70L.. BORDOR70R..	Shower Door <b>700 x 2100 mm</b> , L Left Hand / R Right Hand	667 - 699 mm	675 - 690 mm	£938
BORDOR76L.. BORDOR76R..	Shower Door <b>760 x 2100 mm</b> , L Left Hand / R Right Hand	727 - 759 mm	735 - 750 mm	£969
BORDOR80L.. BORDOR80R..	Shower Door <b>800 x 2100 mm</b> , L Left Hand / R Right Hand	767 - 799 mm	775 - 790 mm	£988
BORDOR90L.. BORDOR90R..	Shower Door <b>900 x 2100 mm</b> , L Left Hand / R Right Hand	867 - 899 mm	875 - 890 mm	£1,073

Please choose your codes depending on width required and add the two letter colour code to it.

**NOTE This item is Handed so Left or Right Hand need to be specified.**

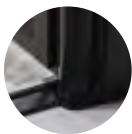

### Pivot hinge

Our Pivot hinge system with a 5 mm rise and fall mechanism. **Pivot swing can be set from 0 to 180 degree position.**

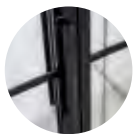

### PHAND

Minimalistic pull handle. Mechanically fixed to Closing Post.

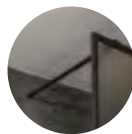

### FXSBCRS

Across Support Bar 1000 mm

**\*\*When Door paired with Return Panel\*\***

### Metalwork Design layout



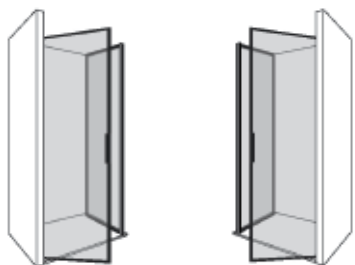

# Return Panels for Shower Doors Enclosures

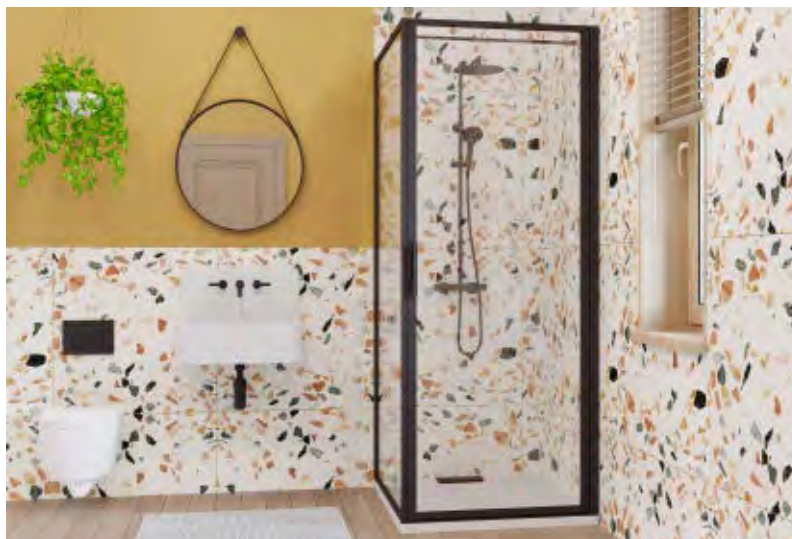

Shower doors may be paired with a range of Return/Side Panels to create Shower Cubicles. Return panels must be ordered with the door.  
If you want to create a Shower Enclosure please follow the steps below:

1. Choose your Door size, handing, colour and glass option and keep the code.
2. Choose the Return size check the hand required and keep the code. Our handing is based on the wall fixing position when you look at it from the outside.
3. Specify both codes on your order and DRENCH will make sure the correct Shower cubicle is delivered including wall fixings, handle and Support bars required.

Item Code	Description	Adjustment Range	Retail Price Exc VAT (Clear Glass)
+BOR70L.. +BOR70R..	Return Panel <b>700 x 2100 mm</b> L Left Hand / R Right Hand <i>**FXSBCRS - Across Support Bar**</i>	675 - 690 mm	£789
+BOR80L.. +BOR80R..	Return Panel <b>800 x 2100 mm</b> L Left Hand / R Right Hand <i>**FXSBCRS - Across Support Bar**</i>	775 - 780 mm	£821
+BOR90L.. +BOR90R..	Return Panel <b>900 x 2100 mm</b> L Left Hand / R Right Hand <i>**FXSBCRS - Across Support Bar**</i>	875 - 890 mm	£841
+BOR100L.. +BOR100R..	Return Panel <b>1000 x 2100 mm</b> L Left Hand / R Right Hand <i>**FXSBCRS - Across Support Bar**</i>	975 - 990 mm	£900

For dimensions that do not fit our Standard range please contact us, We are experts on Bespoke and made to measure projects. Please email us at [sales@drenchshowers.co.uk](mailto:sales@drenchshowers.co.uk).

## MATTE Colours available

	BK	<b>Matt Black</b>	RAL 9005
	GG	<b>Graphite Grey</b>	RAL 7024
	GM	<b>Gun Metal</b>	RAL 8019
	BO	<b>Burnt Orange</b>	RAL 3022
	LY	<b>Lemon Yellow</b>	RAL 1012
	PP	<b>Pale Pink</b>	RAL 3015
	BL	<b>Blanc</b>	RAL 9002
	TT	<b>Total White</b>	RAL 9003
	MI	<b>Mint</b>	RAL 6019
	FO	<b>Forest</b>	RAL 6009
	CB	<b>Capri Blue</b>	RAL 5019
	GN	<b>Grey Navy</b>	RAL 5008

## Metalwork Design layout

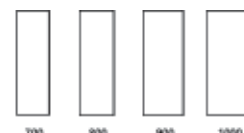

## Shower Door with Return Panel Configurations

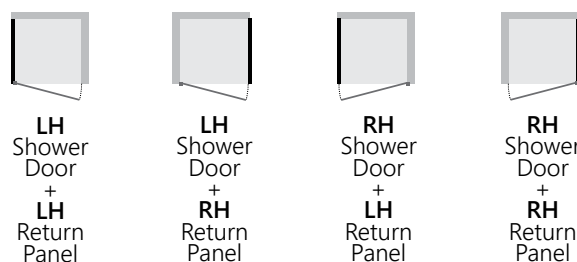

## Glass Options available

Please NOTE other Glass options are available plus additional surcharge to prices listed above.

Plus 45% additional		Plus 35% additional	
	<b>Cross Fluted</b> 8.8 mm TGH Laminated		<b>Fluted</b> 8.8 mm TGH Laminated
	<b>Frosted</b> 8 mm TGH Satin Etch		<b>Grey Tinted</b> 8 mm TGH Smoked glass

Any RAL Classic colours are available **plus 35% to prices above**. For both RAL and Glass Option together please add **65% to prices above**.

# Shower Door with Inline panel



**LH**  
Left Hand

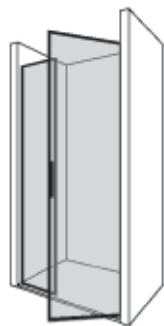

**RH**  
Right Hand

Door is hinged to the wall closing onto an Inline panel. Left or Right hand options are available.

Doors are built using our **pivot hinge**. The 5 mm rise and fall mechanism is manufactured using zinc die castings which give a durable and strong door performance. The **magnetic closing** creates a secure seal after the shower door is closed.

**Pull handle, fixings and door seal are included in the price below.**



Item Code	Description	Adjustment Range	Adjustment Range	Retail Price Exc VAT (Clear Glass)
		In a recess	With Return Panel	
BORDI70/20L.. BORDI70/20R..	Door with Inline <b>900 x 2100 mm</b> (700 mm Door + 200 mm Inline Panel) L Left Hand / R Right Hand <b>**FXSBPRL - Parallel Support Bar included **</b>	867 - 899 mm	875 - 890 mm	£1,189
BORDI70/30L.. BORDI70/30R..	Door with Inline <b>1000 x 2100 mm</b> (700 mm Door + 300 mm Inline Panel) L Left Hand / R Right Hand <b>**FXSBPRL - Parallel Support Bar included **</b>	967 - 999 mm	975 - 990 mm	£1,233
BORDI90/30L.. BORDI90/30R..	Door with Inline <b>1200 x 2100 mm</b> (900 mm Door + 300 mm Inline Panel) L Left Hand / R Right Hand <b>**FXSBPRL - Parallel Support Bar included **</b>	1167 - 1199 mm	1175 - 1190 mm	£1,387
BORDI70/70L.. BORDI70/70R..	Door with Inline <b>1400 x 2100 mm</b> (700 mm Door + 700 mm Inline Panel) L Left Hand / R Right Hand <b>**FXSBPRL - Parallel Support Bar included **</b>	1367 - 1399 mm	1375 - 1390 mm	£1,586
BORDI90/60L.. BORDI90/60R..	Door with Inline <b>1500 x 2100 mm</b> (900 mm Door + 600 mm Inline Panel) L Left Hand / R Right Hand <b>**FXSBPRL - Parallel Support Bar included **</b>	1467 - 1499 mm	1475 - 1490 mm	£1,844
BORDI90/70L.. BORDI90/70R..	Door with Inline <b>1600 x 2100 mm</b> (900 mm Door + 700 mm Inline Panel) L Left Hand / R Right Hand <b>**FXSBPRL - Parallel Support Bar included **</b>	1567 - 1599 mm	1575 - 1590 mm	£1,990

All of our shower doors are Opening OUT, please contact us if Opening INWARDS is required. Please choose your codes depending on width required and add the two letter colour code to it.

**NOTE This item is Handed so Left or Right Hand need to be specified.**

## Metalwork Design layout

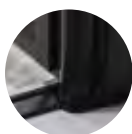

### Pivot hinge

Our Pivot hinge system with a 5 mm rise and fall mechanism. **Pivot swing can be set from 0 to 180 degree position.**



### PHAND

Minimalistic pull handle. Mechanically fixed to Closing Post.



### FXSBPRL

Parallel Support Bar 2000 mm (To be trimmed on site)

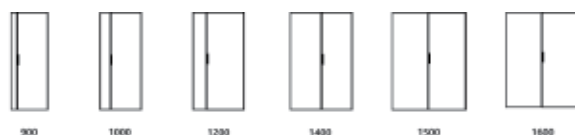



# Return Panels for Shower Door with Inline Enclosures



Shower doors with inline panel may be paired with a range of Return/Side Panels to create shower cubicles.

**Return panels must be ordered with the door.** If you want to create a Shower Enclosure please follow the steps below:

**1. Choose your Door with Inline size,** handing, colour and glass option and keep the code.

**2. Choose the Return size,** check the hand required and keep the code.

*\*\*Our handing is based on the wall fixing position when you look at it from the outside.\*\**

**3. Specify both codes** on your order and DRENCH will make sure the correct Shower cubicle is delivered including wall fixings, handle and Support bars required.

Item Code	Description	Adjustment Range	Retail Price Exc VAT (Clear Glass)
+BOR70L.. +BOR70R..	Return Panel <b>700 x 2100 mm</b> L Left Hand / R Right Hand <i>**FXSBDBL - Return Panel Support Bar**</i>	675 - 690 mm	£789
+BOR80L.. +BOR80R..	Return Panel <b>800 x 2100 mm</b> L Left Hand / R Right Hand <i>**FXSBDBL - Return Panel Support Bar**</i>	775 - 780 mm	£821
+BOR90L.. +BOR90R..	Return Panel <b>900 x 2100 mm</b> L Left Hand / R Right Hand <i>**FXSBDBL - Return Panel Support Bar**</i>	875 - 890 mm	£841
+BOR100L.. +BOR100R..	Return Panel <b>1000 x 2100 mm</b> L Left Hand / R Right Hand <i>**FXSBDBL - Return Panel Support Bar**</i>	975 - 990 mm	£900

*For dimensions that do not fit our Standard range please contact us, We are experts on Bespoke and made to measure projects. Please email us at [sales@drenchshowers.co.uk](mailto:sales@drenchshowers.co.uk).*

## MATTE Colours available

	BK	<b>Matt Black</b>	RAL 9005
	GG	<b>Graphite Grey</b>	RAL 7024
	GM	<b>Gun Metal</b>	RAL 8019
	BO	<b>Burnt Orange</b>	RAL 3022
	LY	<b>Lemon Yellow</b>	RAL 1012
	PP	<b>Pale Pink</b>	RAL 3015
	BL	<b>Blanc</b>	RAL 9002
	TT	<b>Total White</b>	RAL 9003
	MI	<b>Mint</b>	RAL 6019
	FO	<b>Forest</b>	RAL 6009
	CB	<b>Capri Blue</b>	RAL 5019
	GN	<b>Grey Navy</b>	RAL 5008



**FXSBDBL**  
Return panel Support Bar  
2000 mm

*\*\*Included\*\**

## Metalwork Design layout

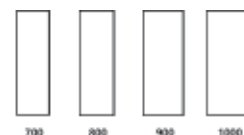

## Shower Door with Inline & Return Panel Configurations

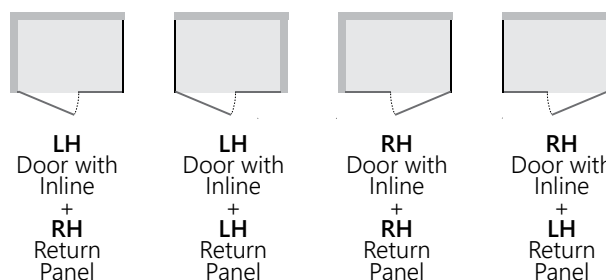

## Glass Options available

Please NOTE other Glass options are available plus additional surcharge to prices listed above.

Plus 45% additional		Plus 35% additional	
	<b>Cross Fluted</b> 8.8 mm TGH Laminated		<b>Fluted</b> 8.8 mm TGH Laminated
	<b>Frosted</b> 8 mm TGH Satin Etch		<b>Grey Tinted</b> 8 mm TGH Smoked glass

*Any RAL Classic colours are available plus 35% to prices above. For both RAL and Glass Option together please add 65% to prices above.*

# Shower Door hinged to Inline panel

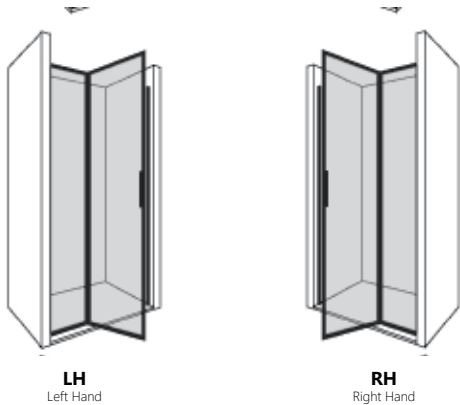

Shower Door is hinged to the Inline panel closing onto the wall. Left or Right hand options are available.

Doors are built using our **pivot hinge**. The 5 mm rise and fall mechanism is manufactured using zinc die castings which give a durable and strong door performance. The **magnetic closing** creates a secure seal after the shower door is closed.

**Pull handle, fixings and sealing components are included in prices below.**



Item Code	Description	Adjustment Range	Adjustment Range	Retail Price Exc VAT (Clear Glass)
		In a recess	With Return Panel	
BORDH70/20L.. BORDH70/20R..	Door hinged to Inline <b>900 x 2100 mm</b> (700 mm Door + 200 mm Inline Panel) L Left Hand / R Right Hand <i>**FXSBPRL - Parallel Support Bar included **</i>	869 - 899 mm	875 - 890 mm	£1,189
BORDH70/30L.. BORDH70/30R..	Door hinged to Inline <b>1000 x 2100 mm</b> (700 mm Door + 300 mm Inline Panel) L Left Hand / R Right Hand <i>**FXSBPRL - Parallel Support Bar included **</i>	969 - 999 mm	975 - 990 mm	£1,233
BORDH90/30L.. BORDH90/30R..	Door hinged to Inline <b>1200 x 2100 mm</b> (900 mm Door + 300 mm Inline Panel) L Left Hand / R Right Hand <i>**FXSBPRL - Parallel Support Bar included **</i>	1169 - 1199 mm	1175 - 1190 mm	£1,387
BORDH70/70L.. BORDH70/70R..	Door hinged to Inline <b>1400 x 2100 mm</b> (700 mm Door + 700 mm Inline Panel) L Left Hand / R Right Hand <i>**FXSBPRL - Parallel Support Bar included **</i>	1369 - 1399 mm	1375 - 1390 mm	£1,586
BORDH90/60L.. BORDH90/60R..	Door hinged to Inline <b>1500 x 2100 mm</b> (900 mm Door + 600 mm Inline Panel) L Left Hand / R Right Hand <i>**FXSBPRL - Parallel Support Bar included **</i>	1469 - 1499 mm	1475 - 1490 mm	£1,844
BORDH90/70L.. BORDH90/70R..	Door hinged to Inline <b>1600 x 2100 mm</b> (900 mm Door + 700 mm Inline Panel) L Left Hand / R Right Hand <i>**FXSBPRL - Parallel Support Bar included **</i>	1569 - 1599 mm	1575 - 1590 mm	£1,990

All of our shower doors are Opening OUT, please contact us if Opening INWARDS is required. Please choose your codes depending on width required and add the two letter colour code to it.

**NOTE This item is Handed so Left or Right Hand need to be specified.**

## Metalwork Design layout

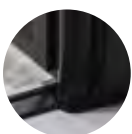

### Pivot hinge

Our Pivot hinge system with a 5 mm rise and fall mechanism. **Pivot swing can be set from 0 to 180 degree position.**

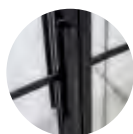

### PHAND

Minimalistic pull handle. Mechanically fixed to Closing Post.



### FXSBPRL

Parallel Support Bar 2000 mm (To be trimmed on site)

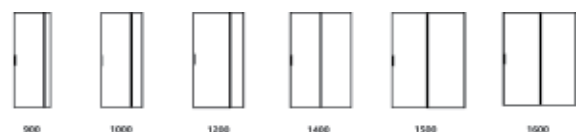

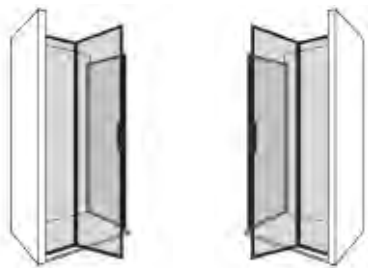

# Return Panels for Shower Door hinged to Inline Enclosures



Shower doors hinged to inline panel may be paired with a range of Return/Side Panels to create shower cubicles.

**Return panels must be ordered with the door.** If you want to create a Shower Enclosure please follow the steps below:

**1. Choose your Door hinged to Inline size,** handing, colour and glass option and keep the code.

**2. Choose the Return size,** check the hand required and keep the code.

*\*\*Our handing is based on the wall fixing position when you look at it from the outside.\*\**

**3. Specify both codes** on your order and DRENCH will make sure the correct Shower cubicle is delivered including wall fixings, handle and Support bars required.

Item Code	Description	Adjustment Range	Retail Price Exc VAT (Clear Glass)
+BOR70L.. +BOR70R..	Return Panel <b>700 x 2100 mm</b> L Left Hand / R Right Hand <i>**FXSBDBL - Return Panel Support Bar**</i>	675 - 690 mm	£789
+BOR80L.. +BOR80R..	Return Panel <b>800 x 2100 mm</b> L Left Hand / R Right Hand <i>**FXSBDBL - Return Panel Support Bar**</i>	775 - 780 mm	£821
+BOR90L.. +BOR90R..	Return Panel <b>900 x 2100 mm</b> L Left Hand / R Right Hand <i>**FXSBDBL - Return Panel Support Bar**</i>	875 - 890 mm	£841
+BOR100L.. +BOR100R..	Return Panel <b>1000 x 2100 mm</b> L Left Hand / R Right Hand <i>**FXSBDBL - Return Panel Support Bar**</i>	975 - 990 mm	£900

*For dimensions that do not fit our Standard range please contact us, We are experts on Bespoke and made to measure projects. Please email us at [sales@drenchshowers.co.uk](mailto:sales@drenchshowers.co.uk).*

## MATTE Colours available

	BK	<b>Matt Black</b>	RAL 9005
	GG	<b>Graphite Grey</b>	RAL 7024
	GM	<b>Gun Metal</b>	RAL 8019
	BO	<b>Burnt Orange</b>	RAL 3022
	LY	<b>Lemon Yellow</b>	RAL 1012
	PP	<b>Pale Pink</b>	RAL 3015
	BL	<b>Blanc</b>	RAL 9002
	TT	<b>Total White</b>	RAL 9003
	MI	<b>Mint</b>	RAL 6019
	FO	<b>Forest</b>	RAL 6009
	CB	<b>Capri Blue</b>	RAL 5019
	GN	<b>Grey Navy</b>	RAL 5008



**FXSBDBL**  
Return panel Support Bar  
2000 mm

*\*\*Included\*\**

## Metalwork Design layout



## Shower Door with Inline & Return Panel Configurations

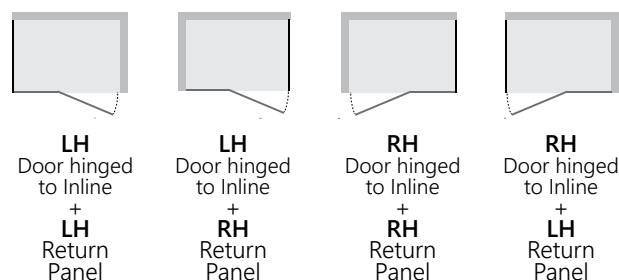

## Glass Options available

Please NOTE other Glass options are available plus additional surcharge to prices listed above.

Plus 45% additional		Plus 35% additional	
	<b>Cross Fluted</b> 8.8 mm TGH Laminated		<b>Fluted</b> 8.8 mm TGH Laminated
	<b>Frosted</b> 8 mm TGH Satin Etch		<b>Grey Tinted</b> 8 mm TGH Smoked glass

*Any RAL Classic colours are available plus 35% to prices above. For both RAL and Glass Option together please add 65% to prices above.*

# Single Shower Doors

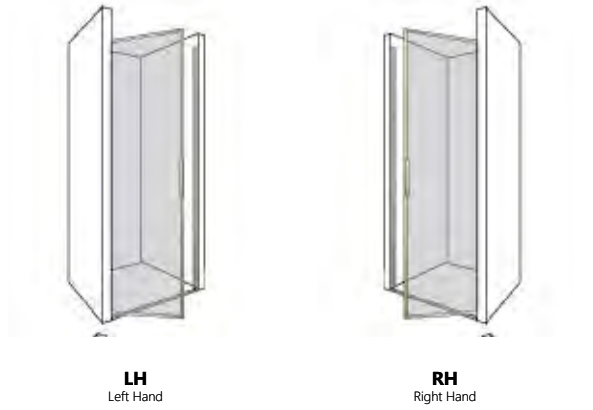

Single doors are suitable for shower recesses. **Left** or **Right** hand options are available.

Doors are built using our **vintage butt hinges**. Each door includes 4 hinges equally positioned and recessed on profiles. The **magnetic closing** creates a secure seal after the shower door is closed.

**Pull handle, fixings and door seal are included in the price below.**



Item Code	Description	Adjustment Range		Retail Price Exc VAT (Clear Glass)
		In a recess	With Return Panel	
BORDOR70L.. BORDOR70R..	Shower Door <b>700 x 2100 mm</b> , L Left Hand / R Right Hand	671 - 689 mm	681 - 690 mm	£1.456
BORDOR76L.. BORDOR76R..	Shower Door <b>760 x 2100 mm</b> , L Left Hand / R Right Hand	721 - 739 mm	739 - 747 mm	£1.498
BORDOR80L.. BORDOR80R..	Shower Door <b>800 x 2100 mm</b> , L Left Hand / R Right Hand	771 - 789 mm	781 - 790 mm	£1.522
BORDOR90L.. BORDOR90R..	Shower Door <b>900 x 2100 mm</b> , L Left Hand / R Right Hand	871 - 889 mm	881 - 890 mm	£1.672

Please choose your codes depending on width required and add the two letter colour code to it.

**NOTE This item is Handed so Left or Right Hand need to be specified.**



### Butt Hinge

Vintage butt hinges. Each door included 4 hinges equally positioned and recessed on profiles.



### SPHAND

Shaped pull handle. Mechanically fixed to Closing Post.



### FXSBCRS

Across Support Bar 1000 mm

**\*\*When Door paired with Return Panel\*\***

### Metalwork Design layout



# Return Panels for Shower Doors Enclosures



Shower doors may be paired with a range of Return/Side Panels to create Shower Cubicles. Return panels must be ordered with the door.  
If you want to create a Shower Enclosure please follow the steps below:

1. Choose your Door size, handing, colour and glass option and keep the code.
2. Choose the Return size check the hand required and keep the code. Our handing is based on the wall fixing position when you look at it from the outside.
3. Specify both codes on your order and DRENCH will make sure the correct Shower cubicle is delivered including wall fixings, handle and Support bars required.



Item Code	Description	Adjustment Range	Retail Price Exc VAT (Clear Glass)
+BOR70L.. +BOR70R..	Return Panel <b>700 x 2100 mm</b> L Left Hand / R Right Hand <i>**FXSBCRS - Accross Support Bar**</i>	675 - 690 mm	£950
+BOR80L.. +BOR80R..	Return Panel <b>800 x 2100 mm</b> L Left Hand / R Right Hand <i>**FXSBCRS - Accross Support Bar**</i>	775 - 780 mm	£1,015
+BOR90L.. +BOR90R..	Return Panel <b>900 x 2100 mm</b> L Left Hand / R Right Hand <i>**FXSBCRS - Accross Support Bar**</i>	875 - 890 mm	£1,063
+BOR100L.. +BOR100R..	Return Panel <b>1000 x 2100 mm</b> L Left Hand / R Right Hand <i>**FXSBCRS - Accross Support Bar**</i>	975 - 990 mm	£1,130

For dimensions that do not fit our Standard range please contact us, We are experts on Bespoke and made to measure projects. Please email us at [sales@drenchshowers.co.uk](mailto:sales@drenchshowers.co.uk).

## Metalwork Design layout

### Metallic Finishes available

	LB	<b>Light Bronze</b>	Anodised
	DB	<b>Dark Bronze</b>	Anodised
	BS	<b>Brushed Steel</b>	Anodised
	BB	<b>Brushed Brass</b>	Anodised

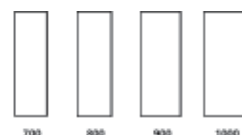

### Shower Door with Return Panel Configurations

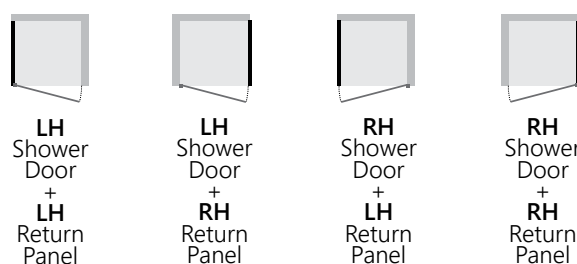

### Glass Options available

Please NOTE other Glass options are available plus additional surcharge to prices listed above.

Plus 45% additional		Plus 35% additional	
	<b>Cross Fluted</b> 8.8 mm TGH Laminated		<b>Fluted</b> 8.8 mm TGH Laminated
	<b>Frosted</b> 8 mm TGH Satin Etch		<b>Grey Tinted</b> 8 mm TGH Smoked glass

# Shower Door with Inline panel

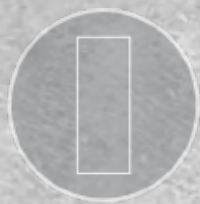

**BORDER**  
Metallic Finishes



**LH**  
Left Hand



**RH**  
Right Hand

Door is hinged to the wall closing onto an Inline panel. Left or Right hand options are available.

Doors are built using 4 vintage ball bearing hinges finished in the metal chosen. The magnetic closing creates a secure seal after the shower door is closed.

Pull handle, fixings and door seal are included in the price below.

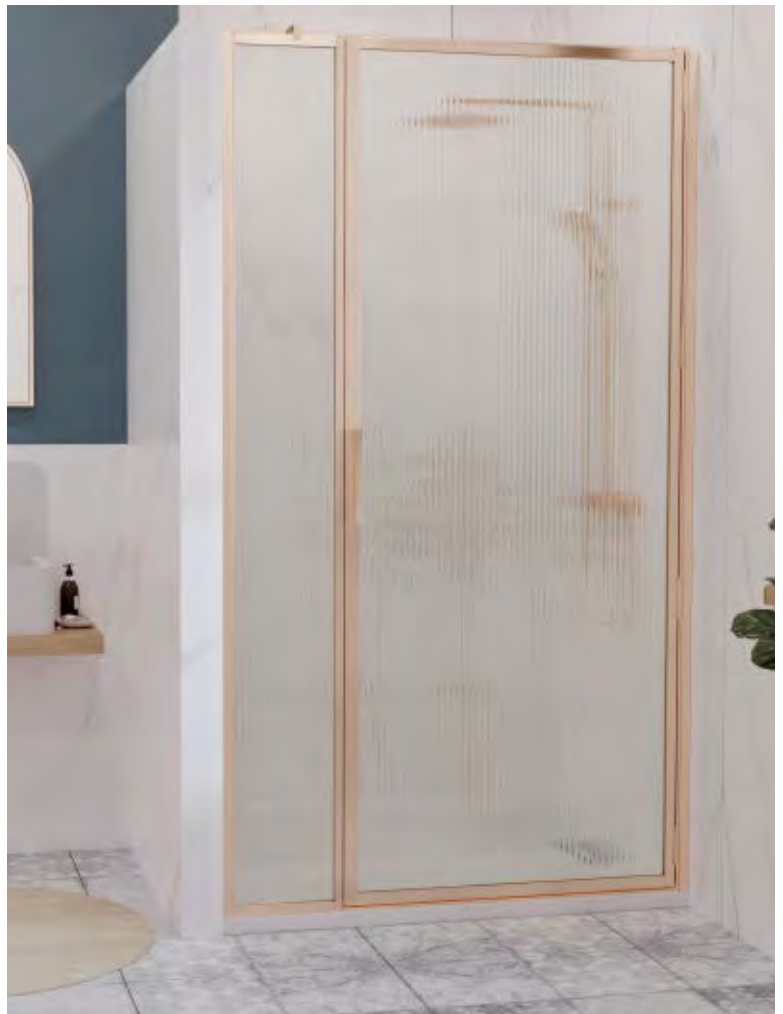

Item Code	Description	Adjustment Range	Adjustment Range	Retail Price Exc VAT (Clear Glass)
		In a recess	With Return Panel	
BORDI70/20L.. BORDI70/20R..	Door with Inline <b>900 x 2100 mm</b> (700 mm Door + 200 mm Inline Panel) L Left Hand / R Right Hand <b>**FXSBPRL - Parallel Support Bar included **</b>	871 - 889 mm	881 - 890 mm	£2,062
BORDI70/30L.. BORDI70/30R..	Door with Inline <b>1000 x 2100 mm</b> (700 mm Door + 300 mm Inline Panel) L Left Hand / R Right Hand <b>**FXSBPRL - Parallel Support Bar included **</b>	971 - 989 mm	981 - 990 mm	£2,132
BORDI90/30L.. BORDI90/30R..	Door with Inline <b>1200 x 2100 mm</b> (900 mm Door + 300 mm Inline Panel) L Left Hand / R Right Hand <b>**FXSBPRL - Parallel Support Bar included **</b>	1171 - 1189 mm	1181 - 1190 mm	£2,273
BORDI70/70L.. BORDI70/70R..	Door with Inline <b>1400 x 2100 mm</b> (700 mm Door + 700 mm Inline Panel) L Left Hand / R Right Hand <b>**FXSBPRL - Parallel Support Bar included **</b>	1371 - 1389 mm	1381 - 1390 mm	£2,414
BORDI90/60L.. BORDI90/60R..	Door with Inline <b>1500 x 2100 mm</b> (900 mm Door + 600 mm Inline Panel) L Left Hand / R Right Hand <b>**FXSBPRL - Parallel Support Bar included **</b>	1471 - 1489 mm	1481 - 1490 mm	£2,503
BORDI90/70L.. BORDI90/70R..	Door with Inline <b>1600 x 2100 mm</b> (900 mm Door + 700 mm Inline Panel) L Left Hand / R Right Hand <b>**FXSBPRL - Parallel Support Bar included **</b>	1571 - 1589 mm	1581 - 1590 mm	£2,540

All of our shower doors are Opening OUT, please contact us if Opening INWARDS is required.  
Please choose your codes depending on width required and add the two letter colour code to it.  
**NOTE This item is Handed so Left or Right Hand need to be specified.**

## Metalwork Design layout



**Butt Hinge**

Vintage butt hinges. Each door included 4 hinges equally positioned and recessed on profiles.



**SPHAND**

Shaped pull handle. Mechanically fixed to Closing Post.



**FXSBPRL**

Parallel Support Bar 2000 mm (To be trimmed on site)

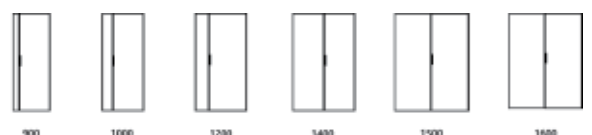



# Return Panels for Shower Door with Inline Enclosures



Shower doors with inline panel may be paired with a range of Return/Side Panels to create shower cubicles. **Return panels must be ordered with the door.** If you want to create a Shower Enclosure please follow the steps below:

**1. Choose your Door with Inline size,** handing, colour and glass option and keep the code.

**2. Choose the Return size,** check the hand required and keep the code.

*\*\*Our handing is based on the wall fixing position when you look at it from the outside.\*\**

**3. Specify both codes** on your order and DRENCH will make sure the correct Shower cubicle is delivered including wall fixings, handle and Support bars required.

Item Code	Description	Adjustment Range	Retail Price Exc VAT (Clear Glass)
+BOR70L.. +BOR70R..	Return Panel <b>700 x 2100 mm</b> L Left Hand / R Right Hand <i>**FXSBDBL - Return Panel Support Bar**</i>	675 - 690 mm	£950
+BOR80L.. +BOR80R..	Return Panel <b>800 x 2100 mm</b> L Left Hand / R Right Hand <i>**FXSBDBL - Return Panel Support Bar**</i>	775 - 780 mm	£1,015
+BOR90L.. +BOR90R..	Return Panel <b>900 x 2100 mm</b> L Left Hand / R Right Hand <i>**FXSBDBL - Return Panel Support Bar**</i>	875 - 890 mm	£1,063
+BOR100L.. +BOR100R..	Return Panel <b>1000 x 2100 mm</b> L Left Hand / R Right Hand <i>**FXSBDBL - Return Panel Support Bar**</i>	975 - 990 mm	£1,130

*For dimensions that do not fit our Standard range please contact us, We are experts on Bespoke and made to measure projects. Please email us at [sales@drenchshowers.co.uk](mailto:sales@drenchshowers.co.uk).*

## Metallic Finishes available

	LB	<b>Light Bronze</b>	Anodised
	DB	<b>Dark Bronze</b>	Anodised
	BS	<b>Brushed Steel</b>	Anodised
	BB	<b>Brushed Brass</b>	Anodised

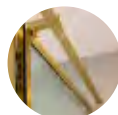

**FXSBDBL**  
Return panel Support Bar  
2000 mm

*\*\*Included\*\**

## Metalwork Design layout



## Shower Door with Inline & Return Panel Configurations

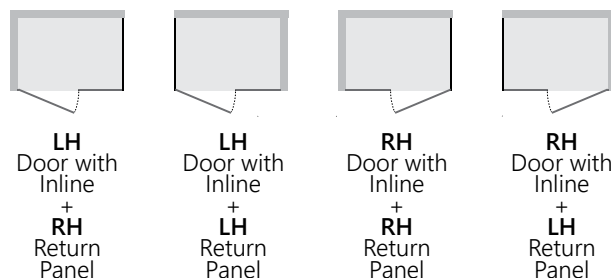

## Glass Options available

Please NOTE other Glass options are available plus additional surcharge to prices listed above.

Plus 45% additional	Plus 35% additional
---------------------	---------------------

<b>Cross Fluted</b> 8.8 mm TGH Laminated	<b>Fluted</b> 8.8 mm TGH Laminated	<b>Frosted</b> 8 mm TGH Satin Etch	<b>Grey Tinted</b> 8 mm TGH Smoked glass

*Any RAL Classic colours are available plus 35% to prices above. For both RAL and Glass Option together please add 65% to prices above.*

# Shower Door hinged to Inline panel

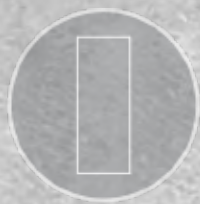

**BORDER**  
Metallic Finishes



**LH**  
Left Hand



**RH**  
Right Hand

Shower Door is hinged to the Inline panel closing onto the wall. Left or Right hand options are available.

Doors are built using 4 vintage ball bearing hinges finished in the metal chosen. The magnetic closing creates a secure seal after the shower door is closed.

Pull handle, fixings and door seal are included in the price below.

Item Code	Description	Adjustment Range	Adjustment Range	Retail Price Exc VAT (Clear Glass)
		In a recess	With Return Panel	
BORDH70/20L... BORDH70/20R...	Door hinged to Inline <b>900 x 2100 mm</b> (700 mm Door + 200 mm Inline Panel) L Left Hand / R Right Hand <i>**FXSBPRL - Parallel Support Bar included **</i>	871 - 889 mm	875 - 890 mm	£2,062
BORDH70/30L... BORDH70/30R...	Door hinged to Inline <b>1000 x 2100 mm</b> (700 mm Door + 300 mm Inline Panel) L Left Hand / R Right Hand <i>**FXSBPRL - Parallel Support Bar included **</i>	971 - 989 mm	975 - 990 mm	£2,132
BORDH90/30L... BORDH90/30R...	Door hinged to Inline <b>1200 x 2100 mm</b> (900 mm Door + 300 mm Inline Panel) L Left Hand / R Right Hand <i>**FXSBPRL - Parallel Support Bar included **</i>	1171 - 1189 mm	1175 - 1190 mm	£2,273
BORDH70/70L... BORDH70/70R...	Door hinged to Inline <b>1400 x 2100 mm</b> (700 mm Door + 700 mm Inline Panel) L Left Hand / R Right Hand <i>**FXSBPRL - Parallel Support Bar included **</i>	1371 - 1389 mm	1375 - 1390 mm	£2,414
BORDH90/60L... BORDH90/60R...	Door hinged to Inline <b>1500 x 2100 mm</b> (900 mm Door + 600 mm Inline Panel) L Left Hand / R Right Hand <i>**FXSBPRL - Parallel Support Bar included **</i>	1471 - 1489 mm	1475 - 1490 mm	£2,503
BORDH90/70L... BORDH90/70R...	Door hinged to Inline <b>1600 x 2100 mm</b> (900 mm Door + 700 mm Inline Panel) L Left Hand / R Right Hand <i>**FXSBPRL - Parallel Support Bar included **</i>	1571 - 1589 mm	1575 - 1590 mm	£2,540

All of our shower doors are Opening OUT, please contact us if Opening INWARDS is required. Please choose your codes depending on width required and add the two letter colour code to it.

**NOTE** This item is Handed so Left or Right Hand need to be specified.

## Metalwork Design layout



**Butt Hinge**

Vintage butt hinges. Each door included 4 hinges equally positioned and recessed on profiles.



**SPHAND**

Shaped pull handle. Mechanically fixed to Closing Post.



**FXSBPRL**

Parallel Support Bar 2000 mm (To be trimmed on site)

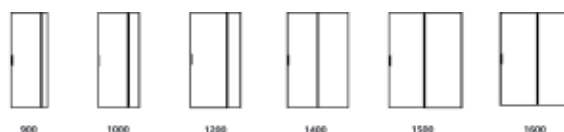



# Return Panels for Shower Door hinged to Inline Enclosures



Shower doors hinged to inline panel may be paired with a range of Return/Side Panels to create shower cubicles. **Return panels must be ordered with the door.** If you want to create a Shower Enclosure please follow the steps below:

- 1. Choose your Door hinged to Inline size,** handing, colour and glass option and keep the code.
- 2. Choose the Return size,** check the hand required and keep the code.  
*\*\*Our handing is based on the wall fixing position when you look at it from the outside.\*\**
- 3. Specify both codes** on your order and DRENCH will make sure the correct Shower cubicle is delivered including wall fixings, handle and Support bars required.

Item Code	Description	Adjustment Range	Retail Price Exc VAT (Clear Glass)
+BOR70L.. +BOR70R..	Return Panel <b>700 x 2100 mm</b> L Left Hand / R Right Hand <i>**FXSDBDL - Return Panel Support Bar**</i>	675 - 690 mm	£950
+BOR80L.. +BOR80R..	Return Panel <b>800 x 2100 mm</b> L Left Hand / R Right Hand <i>**FXSDBDL - Return Panel Support Bar**</i>	775 - 780 mm	£1,015
+BOR90L.. +BOR90R..	Return Panel <b>900 x 2100 mm</b> L Left Hand / R Right Hand <i>**FXSDBDL - Return Panel Support Bar**</i>	875 - 890 mm	£1,063
+BOR100L.. +BOR100R..	Return Panel <b>1000 x 2100 mm</b> L Left Hand / R Right Hand <i>**FXSDBDL - Return Panel Support Bar**</i>	975 - 990 mm	£1,130

*For dimensions that do not fit our Standard range please contact us, We are experts on Bespoke and made to measure projects. Please email us at [sales@drenchshowers.co.uk](mailto:sales@drenchshowers.co.uk).*

## Metallic Finishes available

	LB	<b>Light Bronze</b>	Anodised
	DB	<b>Dark Bronze</b>	Anodised
	BS	<b>Brushed Steel</b>	Anodised
	BB	<b>Brushed Brass</b>	Anodised



**FXSDBDL**  
Return panel Support Bar  
2000 mm

*\*\*Included\*\**

## Metalwork Design layout

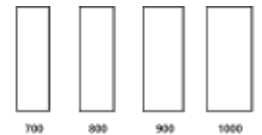

## Shower Door with Inline & Return Panel Configurations

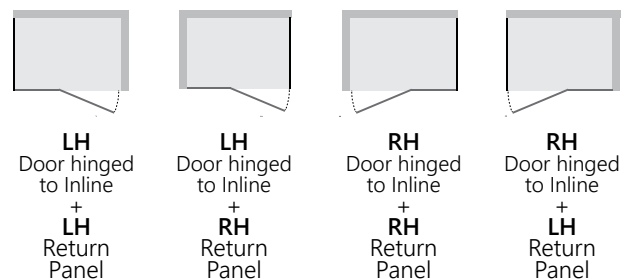

## Glass Options available

Please NOTE other Glass options are available plus additional surcharge to prices listed above.

Plus 45% additional		Plus 35% additional	
	<b>Cross Fluted</b> 8.8 mm TGH Laminated		<b>Fluted</b> 8.8 mm TGH Laminated
	<b>Frosted</b> 8 mm TGH Satin Etch		<b>Grey Tinted</b> 8 mm TGH Smoked glass

*Any RAL Classic colours are available plus 35% to prices above. For both RAL and Glass Option together please add 65% to prices above.*



*Shower Door hinged to Inline 1200 x 2100 mm Forest & Brushed Brass Touch,  
Crossed Fluted Glass*



# TOUCHES

Collection





# TOUCHES Collection

## FEATURES:

Shower Doors & Enclosures

2100 mm Height

12 MATTE Colours

4 Metallic TOUCHES

8 mm Toughened Glass

(Fluted, Frosted, Grey Tinted & Clear Glass options)

Easy Clean Coating

MATTE Colours and Metallic finishes merge seamlessly in our TOUCHES Collection offering a high level of customisation. We want to manufactured your favourite choice of MATTE and metallic finishes. It is all about matching and we know it.

**Shower Door frames and spare parts are finished in a MATTE Colour using architectural powder coating and the little touches like Hinges and Pull Handle are finished in Metallic.**

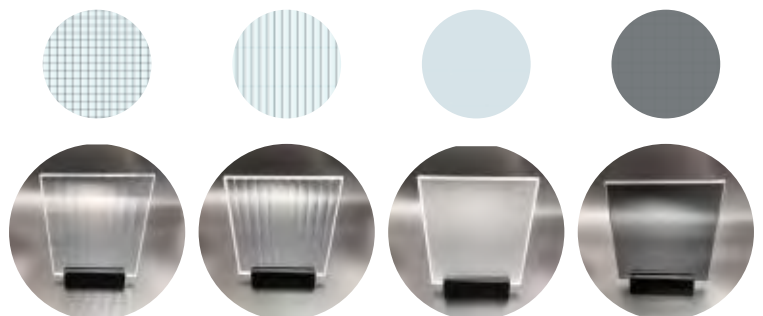
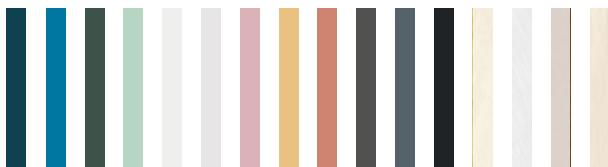

**Cross Fluted**

8.8 mm THG Laminated

**Fluted**

8.8 mm THG Laminated

**Frosted**

8 mm THG Satin Etch

**Grey Tinted**

8 mm THG Smoked glass



**Product Configurations Available**



Choose the metallic touch to your Shower Enclosure.

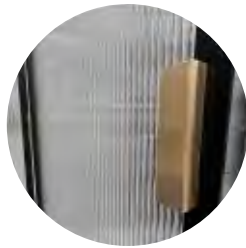

**+TOUCHBB**  
Brushed Brass  
Pull Handle & Hinges

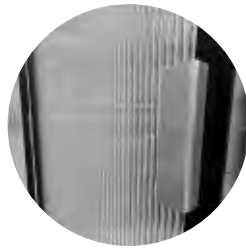

**+TOUCHBS**  
Brushed Steel  
Pull Handle & Hinges

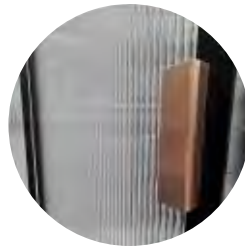



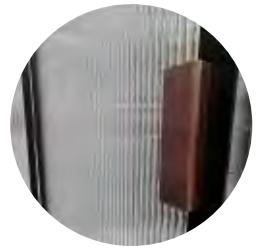















**+TOUCHLB**  
Light Bronze  
Pull Handle & Hinges



**+TOUCHDB**  
Dark Bronze  
Pull Handle & Hinges



**Standard Dimensions Vs Product Configuration**

	300	400	500	600	700	800	900	1000	1200	1400	1500	1600
 <b>Single Shower Doors</b> Standard Height 2100 mm	×	×	×	×				×	×	×	×	×
 <b>Shower Doors with Inline Panel</b> Standard Height 2100 mm	×	×	×	×	×	×						
 <b>Shower Doors hinged to Inline Panel</b> Standard Height 2100 mm	×	×	×	×	×	×						
 <b>Return Panels for Shower Enclosures</b> Standard Height 2100 mm	×	×	×	×					×	×	×	×



## Single Shower Doors



**LH**  
Left Hand



**RH**  
Right Hand

Single doors are suitable for shower recesses. **Left or Right** hand options are available.

Doors are built using our **vintage butt hinges**. Each door includes 4 hinges equally positioned and recessed on profiles. The **magnetic closing** creates a secure seal after the shower door is closed.

**Pull handle, fixings and door seal are included in the price below.**

Item Code	Description	Adjustment Range	Adjustment Range	Retail Price Exc VAT (Clear Glass)
		In a recess	With Return Panel	
TOUDOR70L.. TOUDOR70R..	Shower Door <b>700 x 2100 mm</b> , L Left Hand / R Right Hand	671 - 689 mm	681 - 690 mm	£1,192
TOUDOR76L.. TOUDOR76R..	Shower Door <b>760 x 2100 mm</b> , L Left Hand / R Right Hand	721 - 739 mm	739 - 747 mm	£1,307
TOUDOR80L.. TOUDOR80R..	Shower Door <b>800 x 2100 mm</b> , L Left Hand / R Right Hand	771 - 789 mm	781 - 790 mm	£1,373
TOUDOR90L.. TOUDOR90R..	Shower Door <b>900 x 2100 mm</b> , L Left Hand / R Right Hand	871 - 889 mm	881 - 890 mm	£1,529

Please choose your codes depending on width required and add the two letter colour code to it.

**NOTE This item is Handed so Left or Right Hand need to be specified.**

### Metalwork Design layout

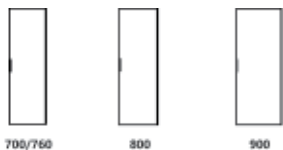

700/760

800

900

Please choose your metallic TOUCH and specify the +TOUCHXX code.



**+TOUCHBB**  
Brushed Brass  
Pull Handle & Hinges

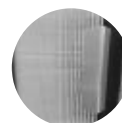

**+TOUCHBS**  
Brushed Steel  
Pull Handle & Hinges



**+TOUCHLB**  
Light Bronze  
Pull Handle & Hinges

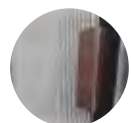

**+TOUCHDB**  
Dark Bronze  
Pull Handle & Hinges

# Return Panels for Shower Doors Enclosures

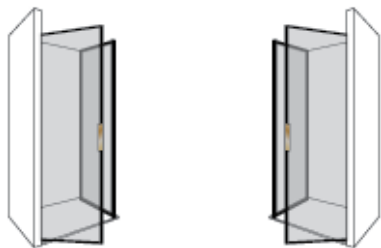

Shower doors may be paired with a range of Return/Side Panels to create Shower Cubicles. Return panels must be ordered with the door.  
If you want to create a Shower Enclosure please follow the steps below:

1. Choose your Door size, handing, colour and glass option and keep the code.
2. Choose the Return size check the hand required and keep the code. Our handing is based on the wall fixing position when you look at it from the outside.
3. Specify both codes on your order and DRENCH will make sure the correct Shower cubicle is delivered including wall fixings, handle and Support bars required.



Item Code	Description	Adjustment Range	Retail Price Exc VAT (Clear Glass)
+TOU70L.. +TOU70R..	Return Panel <b>700 x 2100 mm</b> L Left Hand / R Right Hand <i>**FXSBCRS - Across Support Bar**</i>	675 - 690 mm	£675
+TOU80L.. +TOU80R..	Return Panel <b>800 x 2100 mm</b> L Left Hand / R Right Hand <i>**FXSBCRS - Across Support Bar**</i>	775 - 780 mm	£712
+TOU90L.. +TOU90R..	Return Panel <b>900 x 2100 mm</b> L Left Hand / R Right Hand <i>**FXSBCRS - Across Support Bar**</i>	875 - 890 mm	£738
+TOU100L.. +TOU100R..	Return Panel <b>1000 x 2100 mm</b> L Left Hand / R Right Hand <i>**FXSBCRS - Across Support Bar**</i>	975 - 990 mm	£819

For dimensions that do not fit our Standard range please contact us, We are experts on Bespoke and made to measure projects. Please email us at [sales@drenchshowers.co.uk](mailto:sales@drenchshowers.co.uk).

## MATTE Colours available

	BK	<b>Matt Black</b>	RAL 9005
	GG	<b>Graphite Grey</b>	RAL 7024
	GM	<b>Gun Metal</b>	RAL 8019
	BO	<b>Burnt Orange</b>	RAL 3022
	LY	<b>Lemon Yellow</b>	RAL 1012
	PP	<b>Pale Pink</b>	RAL 3015
	BL	<b>Blanc</b>	RAL 9002
	TT	<b>Total White</b>	RAL 9003
	MI	<b>Mint</b>	RAL 6019
	FO	<b>Forest</b>	RAL 6009
	CB	<b>Capri Blue</b>	RAL 5019
	GN	<b>Grey Navy</b>	RAL 5008

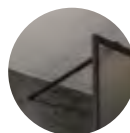

**FXSBCRS**  
Across Support Bar  
1000 mm

## Metalwork Design layout

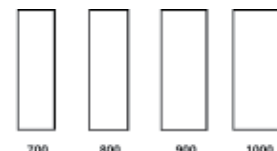

## Shower Door with Return Panel Configurations

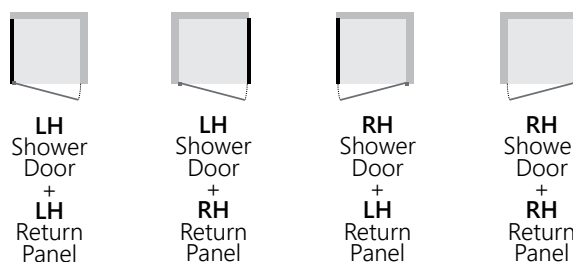

## Glass Options available

Please NOTE other Glass options are available plus additional surcharge to prices listed above.

Plus 45% additional		Plus 35% additional	
	<b>Cross Fluted</b> 8.8 mm TGH Laminated		<b>Fluted</b> 8.8 mm TGH Laminated
	<b>Frosted</b> 8 mm TGH Satin Etch		<b>Grey Tinted</b> 8 mm TGH Smoked glass

Any RAL Classic colours are available **plus 35% to prices above**. For both RAL and Glass Option together please add **65% to prices above**.



**LH**  
Left Hand



**RH**  
Right Hand



## Shower Door with Inline panel

Door is hinged to the wall closing onto an Inline panel. Left or Right hand options are available.

Doors are built using 4 vintage ball bearing hinges finished on the metal chosen. The magnetic closing creates a secure seal after the shower door is closed.

Pull handle, fixings and sealing components are included in prices below.



**TOUCHES**  
Collection



**FXSBPRL**  
Parallel Support Bar  
1600 mm

\*\*Included on units wider than 1200 mm\*\*

Item Code	Description	Adjustment Range	Adjustment Range	Retail Price Ex VAT (Clear Glass)
		In a recess	With Return Panel	
TOUDI70/20L.. TOUDI70/20R..	Door with Inline <b>900 x 2100 mm</b> (700 mm Door + 200 mm Inline Panel) L Left Hand / R Right Hand **FXSBPRL - Parallel Support Bar included**	871 - 889 mm	881 - 890 mm	£1,529
TOUDI70/30L.. TOUDI70/30R..	Door with Inline <b>1000 x 2100 mm</b> (700 mm Door + 300 mm Inline Panel) L Left Hand / R Right Hand **FXSBPRL - Parallel Support Bar included**	971 - 989 mm	981 - 990 mm	£1,781
TOUDI90/30L.. TOUDI90/30R..	Door with Inline <b>1200 x 2100 mm</b> (900 mm Door + 300 mm Inline Panel) L Left Hand / R Right Hand **FXSBPRL - Parallel Support Bar included**	1171 - 1189 mm	1181 - 1190 mm	£2,080
TOUDI70/70L.. TOUDI70/70R..	Door with Inline <b>1400 x 2100 mm</b> (700 mm Door + 700 mm Inline Panel) L Left Hand / R Right Hand **FXSBPRL - Parallel Support Bar included**	1371 - 1389 mm	1381 - 1390 mm	£2,265
TOUDI90/60L.. TOUDI90/60R..	Door with Inline <b>1500 x 2100 mm</b> (900 mm Door + 600 mm Inline Panel) L Left Hand / R Right Hand **FXSBPRL - Parallel Support Bar included**	1471 - 1489 mm	1481 - 1490 mm	£2,513

All of our shower doors are Opening OUT, please contact us if Opening INWARDS is required. Please choose your codes depending on width required and add the two letter colour code to it. **NOTE This item is Handed so Left or Right Hand need to be specified.**

### Metalwork Design layout

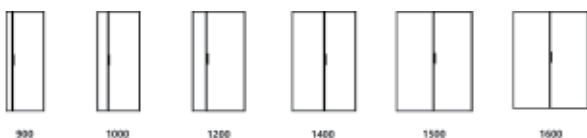

Please choose your metallic TOUCH and specify the +TOUCHXX code.

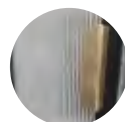

**+TOUCHBB**  
Brushed Brass  
Pull Handle & Hinges

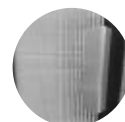

**+TOUCHBS**  
Brushed Steel  
Pull Handle & Hinges



**+TOUCHLB**  
Light Bronze  
Pull Handle & Hinges

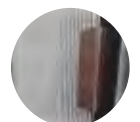

**+TOUCHDB**  
Dark Bronze  
Pull Handle & Hinges

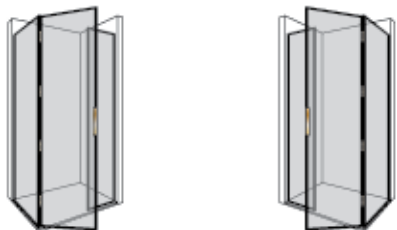

# Return Panels for Shower Door with Inline Enclosures

Shower doors with inline panel may be paired with a range of Return/Side Panels to create shower cubicles. **Return panels must be ordered with the door.** If you want to create a Shower Enclosure please follow the steps below:

**1. Choose your Door with Inline size,** handing, colour and glass option and keep the code.

**2. Choose the Return size,** check the hand required and keep the code.

*\*\*Our handing is based on the wall fixing position when you look at it from the outside.\*\**

**3. Specify both codes** on your order and DRENCH will make sure the correct Shower cubicle is delivered including wall fixings, handle and Support bars required.



Item Code	Description	Adjustment Range	Retail Price Exc VAT (Clear Glass)
+TOU70L.. +TOU70R..	Return Panel <b>700 x 2100 mm</b> L Left Hand / R Right Hand <i>**FXSBDBL - Return Panel Support Bar**</i>	675 - 690 mm	£675
+TOU80L.. +TOU80R..	Return Panel <b>800 x 2100 mm</b> L Left Hand / R Right Hand <i>**FXSBDBL - Return Panel Support Bar**</i>	775 - 780 mm	£712
+TOU90L.. +TOU90R..	Return Panel <b>900 x 2100 mm</b> L Left Hand / R Right Hand <i>**FXSBDBL - Return Panel Support Bar**</i>	875 - 890 mm	£738
+TOU100L.. +TOU100R..	Return Panel <b>1000 x 2100 mm</b> L Left Hand / R Right Hand <i>**FXSBDBL - Return Panel Support Bar**</i>	975 - 990 mm	£819

*For dimensions that do not fit our Standard range please contact us, We are experts on Bespoke and made to measure projects. Please email us at [sales@drenchshowers.co.uk](mailto:sales@drenchshowers.co.uk).*

## MATTE Colours available

	BK	<b>Matt Black</b>	RAL 9005
	GG	<b>Graphite Grey</b>	RAL 7024
	GM	<b>Gun Metal</b>	RAL 8019
	BO	<b>Burnt Orange</b>	RAL 3022
	LY	<b>Lemon Yellow</b>	RAL 1012
	PP	<b>Pale Pink</b>	RAL 3015
	BL	<b>Blanc</b>	RAL 9002
	TT	<b>Total White</b>	RAL 9003
	MI	<b>Mint</b>	RAL 6019
	FO	<b>Forest</b>	RAL 6009
	CB	<b>Capri Blue</b>	RAL 5019
	GN	<b>Grey Navy</b>	RAL 5008



**FXSBDBL**  
Return panel Support Bar  
1600 mm

*\*\*Included\*\**

## Metalwork Design layout

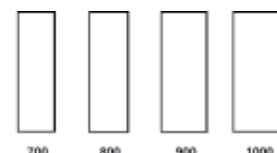

## Shower Door with Inline & Return Panel Configurations

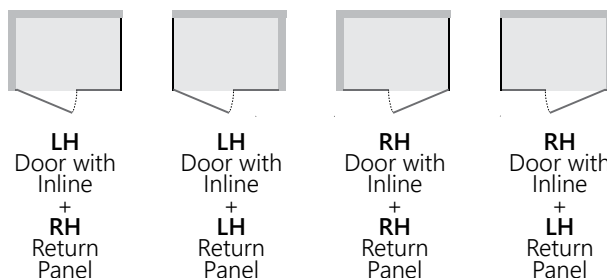

## Glass Options available

Please NOTE other Glass options are available plus additional surcharge to prices listed above.

Plus 45% additional		Plus 35% additional	
	<b>Cross Fluted</b> 8.8 mm TGH Laminated		<b>Fluted</b> 8.8 mm TGH Laminated
	<b>Frosted</b> 8 mm TGH Satin Etch		<b>Grey Tinted</b> 8 mm TGH Smoked glass

*Any RAL Classic colours are available plus 35% to prices above. For both RAL and Glass Option together please add 65% to prices above.*



**LH**  
Left Hand



**RH**  
Right Hand



## Shower Door hinged to Inline panel

Door is hinged to the wall closing onto an Inline panel. Left or Right hand options are available.

Doors are built using 4 vintage ball bearing hinges finished on the metal chosen. The magnetic closing creates a secure seal after the shower door is closed.

Pull handle, fixings and sealing components are included in prices below.



**FXSBPRL**  
Parallel Support Bar  
1600 mm

\*\*Included on units wider than 1200 mm\*\*

Item Code	Description	Adjustment Range	Adjustment Range	Retail Price Exc VAT (Clear Glass)
		In a recess	With Return Panel	
TOUDH70/20L.. TOUDH70/20R..	Door hinged to Inline <b>900 x 2100 mm</b> (700 mm Door + 200 mm Inline Panel) L Left Hand / R Right Hand <i>**FXSBPRL - Parallel Support Bar included**</i>	871 - 889 mm	881 - 890 mm	£1,529
TOUDH70/30L.. TOUDH70/30R..	Door hinged to Inline <b>1000 x 2100 mm</b> (700 mm Door + 300 mm Inline Panel) L Left Hand / R Right Hand <i>**FXSBPRL - Parallel Support Bar included**</i>	971 - 989 mm	981 - 990 mm	£1,781
TOUDH90/30L.. TOUDH90/30R..	Door hinged to Inline <b>1200 x 2100 mm</b> (900 mm Door + 300 mm Inline Panel) L Left Hand / R Right Hand <i>**FXSBPRL - Parallel Support Bar included**</i>	1171 - 1189 mm	1181 - 1190 mm	£2,080
TOUDH70/70L.. TOUDH70/70R..	Door hinged to Inline <b>1400 x 2100 mm</b> (700 mm Door + 700 mm Inline Panel) L Left Hand / R Right Hand <i>**FXSBPRL - Parallel Support Bar included**</i>	1371 - 1389 mm	1381 - 1390 mm	£2,265
TOUDH90/60L.. TOUDH90/60R..	Door hinged to Inline <b>1500 x 2100 mm</b> (900 mm Door + 600 mm Inline Panel) L Left Hand / R Right Hand <i>**FXSBPRL - Parallel Support Bar included**</i>	1471 - 1489 mm	1481 - 1490 mm	£2,513
TOUDH90/70L.. TOUDH90/70R..	Door hinged to Inline <b>1600 x 2100 mm</b> (900 mm Door + 700 mm Inline Panel) L Left Hand / R Right Hand <i>**FXSBPRL - Parallel Support Bar included**</i>	1571 - 1589 mm	1581 - 1590 mm	£2,686

All of our shower doors are Opening OUT, please contact us if Opening INWARDS is required. Please choose your codes depending on width required and add the two letter colour code to it. **NOTE This item is Handed so Left or Right Hand need to be specified.**

### Metalwork Design layout

Please choose your metallic TOUCH and specify the +TOUCHXX code.

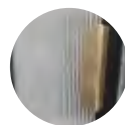
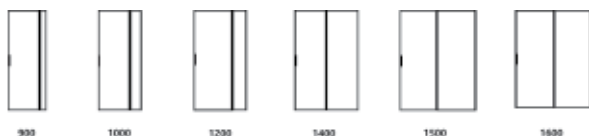

**+TOUCHBB**  
Brushed Brass  
Pull Handle & Hinges

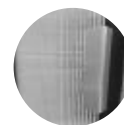

**+TOUCHBS**  
Brushed Steel  
Pull Handle & Hinges



**+TOUCHLB**  
Light Bronze  
Pull Handle & Hinges

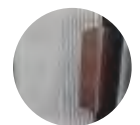

**+TOUCHDB**  
Dark Bronze  
Pull Handle & Hinges

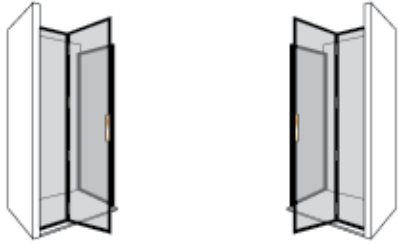

# Return Panels for Shower Door with Inline Enclosures



Shower doors with inline panel may be paired with a range of Return/Side Panels to create shower cubicles. **Return panels must be ordered with the door.** If you want to create a Shower Enclosure please follow the steps below:

- 1. Choose your Door with Inline size,** handing, colour and glass option and keep the code.
- 2. Choose the Return size,** check the hand required and keep the code.  
\*\*Our handing is based on the wall fixing position when you look at it from the outside.\*\*
- 3. Specify both codes** on your order and DRENCH will make sure the correct Shower cubicle is delivered including wall fixings, handle and Support bars required.

Item Code	Description	Adjustment Range	Retail Price Exc VAT (Clear Glass)
+TOU70L.. +TOU70R..	Return Panel <b>700 x 2100 mm</b> L Left Hand / R Right Hand <i>**FXSBDBL - Return Panel Support Bar**</i>	675 - 690 mm	£675
+TOU80L.. +TOU80R..	Return Panel <b>800 x 2100 mm</b> L Left Hand / R Right Hand <i>**FXSBDBL - Return Panel Support Bar**</i>	775 - 780 mm	£712
+TOU90L.. +TOU90R..	Return Panel <b>900 x 2100 mm</b> L Left Hand / R Right Hand <i>**FXSBDBL - Return Panel Support Bar**</i>	875 - 890 mm	£738
+TOU100L.. +TOU100R..	Return Panel <b>1000 x 2100 mm</b> L Left Hand / R Right Hand <i>**FXSBDBL - Return Panel Support Bar**</i>	975 - 990 mm	£819

For dimensions that do not fit our Standard range please contact us, We are experts on Bespoke and made to measure projects. Please email us at [sales@drenchshowers.co.uk](mailto:sales@drenchshowers.co.uk).

## MATTE Colours available

	BK	<b>Matt Black</b>	RAL 9005
	GG	<b>Graphite Grey</b>	RAL 7024
	GM	<b>Gun Metal</b>	RAL 8019
	BO	<b>Burnt Orange</b>	RAL 3022
	LY	<b>Lemon Yellow</b>	RAL 1012
	PP	<b>Pale Pink</b>	RAL 3015
	BL	<b>Blanc</b>	RAL 9002
	TT	<b>Total White</b>	RAL 9003
	MI	<b>Mint</b>	RAL 6019
	FO	<b>Forest</b>	RAL 6009
	CB	<b>Capri Blue</b>	RAL 5019
	GN	<b>Grey Navy</b>	RAL 5008

Any RAL Classic colours are available **plus 35% to prices above.** For both RAL and Glass Option together please add **65% to prices above.**



**FXSBDBL**  
Return panel Support Bar  
1600 mm

**\*\*Included\*\***

## Metalwork Design layout

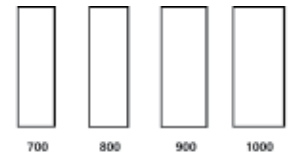

## Shower Door hinged to Inline & Return Panel Configurations

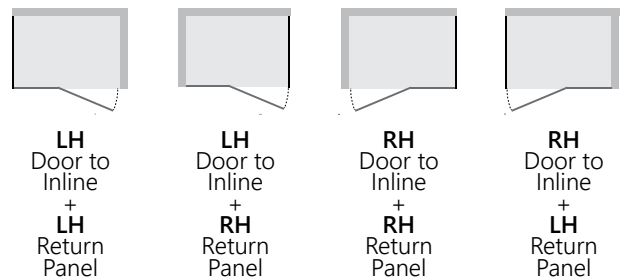

## Glass Options available

Please NOTE other Glass options are available plus additional surcharge to prices listed above.

Plus 45% additional		Plus 35% additional	
	<b>Cross Fluted</b> 8.8 mm TGH Laminated		<b>Fluted</b> 8.8 mm TGH Laminated
	<b>Frosted</b> 8 mm TGH Satin Etch		<b>Grey Tinted</b> 8 mm TGH Smoked glass



# BASE

SHOWER TRAY COLLECTION

## FEATURES:

- Non Slip Slate finish Shower Trays*
- 4 Colours Available*
- McAlpine Waste included on Price*
- Stainless Steel Grate Included*
- Bespoke Grate options*
- Bespoke sizes are available!*

Exclusively designed for DRENCH Showers by one of the most reputed shower tray manufacturers in the European Bathroom Industry. BASE collection presents our range of slate textured shower trays to match and be used along with our Shower Panels and Enclosures.

The Shower Trays main component is polyurethane resin. This is a material of high quality, resistance, durability and elasticity. Its impact resistance and its resistance to bending, make the tray durable and resistant to breakage.



**Total White**  
(TT)  
RAL 9003



**Blanc**  
(BL)  
RAL 9002

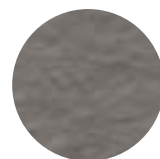

**Dusty Grey**  
(DG)  
RAL 7037



**Graphite Grey**  
(GG)  
RAL 7024

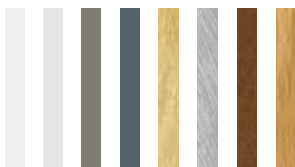

**Product Configurations Available**

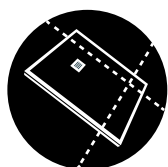

**Easy to customise**

BASE Shower Trays can be cut along both the length and width. They can be cut up to three times to adapt to spaces such as columns or projections. Cutting tools like jig saws or angle grinders with diamond blades are suitable for the job.



**Bacterial Resistant**

The coating technology used during manufacturing gives unique qualities which help the surface with fungicidal, antibacterial and hydrophobic properties. As a result, the shower trays are not only easy cleanable, but also actively help to keep surfaces decontaminated.



**Easy to Install**

BASE Shower trays can be installed flat to tiles, on top of flooring or even using a raising up. Shower tray thickness of 25 mm contributes to an easy installation plus offers versatility of suitable scenarios.



**Non-Slip Surface**

BASE Shower Trays have a matte, non-slip surface which is given by the texture and material used. Effectively preventing slip hazards.

**Standard Dimensions (mm)**

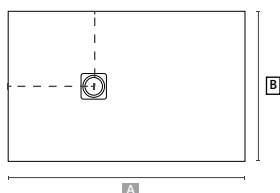

	A	800	900	1000	1200	1400	1500	1600	1700	1800	2000
<b>B</b>											
700 mm		✗	✗	●	●	●	✗	●	●	●	●
800 mm		●	✗	●	●	●	●	●	●	●	●
900 mm		✗	●	●	●	●	●	●	●	●	●

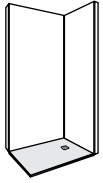

# BAS<sub>E</sub>

SHOWER TRAY COLLECTION

With four colour options and different grating styles, we encourage your mind to be creative. BASE Shower Trays include both Standard Stainless Steel Grating & McAlpine Waste on price.



(TT)



(BL)



(DG)



(GG)

Item Description A x B (mm)	Drain position C & D (mm)	Total White Code	Blanc Code	Dusty Grey Code	Graphite Grey Code	Retail Price (Exc VAT)
Shower Tray Slate texture <b>800 x 800 mm</b>	<b>C: 200 D: 400</b>	BAS8080TT	BAS8080BL	BAS8080DG	BAS8080GG	£502
Shower Tray Slate texture <b>900 x 900 mm</b>	<b>C: 200 D: 450</b>	BAS9090TT	BAS9090BL	BAS9090DG	BAS9090GG	£575
Shower Tray Slate texture <b>1000 x 700 mm</b>	<b>C: 200 D: 350</b>	BAS10070TT	BAS10070BL	BAS10070DG	BAS10070GG	£512
Shower Tray Slate texture <b>1000 x 800 mm</b>	<b>C: 200 D: 400</b>	BAS10080TT	BAS10080BL	BAS10080DG	BAS10080GG	£572
Shower Tray Slate texture <b>1000 x 900 mm</b>	<b>C: 200 D: 450</b>	BAS10090TT	BAS10090BL	BAS10090DG	BAS10090GG	£550
Shower Tray Slate texture <b>1200 x 700 mm</b>	<b>C: 250 D: 350</b>	BAS12070TT	BAS12070BL	BAS12070DG	BAS12070GG	£581
Shower Tray Slate texture <b>1200 x 800 mm</b>	<b>C: 250 D: 400</b>	BAS12080TT	BAS12080BL	BAS12080DG	BAS12080GG	£587
Shower Tray Slate texture <b>1200 x 900 mm</b>	<b>C: 250 D: 450</b>	BAS12090TT	BAS12090BL	BAS12090DG	BAS12090GG	£654
Shower Tray Slate texture <b>1400 x 700 mm</b>	<b>C: 300 D: 350</b>	BAS14070TT	BAS14070BL	BAS14070DG	BAS14070GG	£608
Shower Tray Slate texture <b>1400 x 800 mm</b>	<b>C: 300 D: 400</b>	BAS14080TT	BAS14080BL	BAS14080DG	BAS14080GG	£675
Shower Tray Slate texture <b>1400 x 900 mm</b>	<b>C: 300 D: 450</b>	BAS14090TT	BAS14090BL	BAS14090DG	BAS14090GG	£730
Shower Tray Slate texture <b>1500 x 800 mm</b>	<b>C: 600 D: 400</b>	BAS15080TT	BAS15080BL	BAS15080DG	BAS15080GG	£761
Shower Tray Slate texture <b>1500 x 900 mm</b>	<b>C: 600 D: 450</b>	BAS15090TT	BAS15090BL	BAS15090DG	BAS15090GG	£823
Shower Tray Slate texture <b>1600 x 700 mm</b>	<b>C: 600 D: 350</b>	BAS16070TT	BAS16070BL	BAS16070DG	BAS16070GG	£702
Shower Tray Slate texture <b>1600 x 800 mm</b>	<b>C: 600 D: 400</b>	BAS16080TT	BAS16080BL	BAS16080DG	BAS16080GG	£765
Shower Tray Slate texture <b>1600 x 900 mm</b>	<b>C: 600 D: 450</b>	BAS16090TT	BAS16090BL	BAS16090DG	BAS16090GG	£830
Shower Tray Slate texture <b>1700 x 700 mm</b>	<b>C: 600 D: 350</b>	BAS17070TT	BAS17070BL	BAS17070DG	BAS17070GG	£755
Shower Tray Slate texture <b>1700 x 800 mm</b>	<b>C: 600 D: 400</b>	BAS17080TT	BAS17080BL	BAS17080DG	BAS17080GG	£824
Shower Tray Slate texture <b>1700 x 900 mm</b>	<b>C: 600 D: 450</b>	BAS17090TT	BAS17090BL	BAS17090DG	BAS17090GG	£894
Shower Tray Slate texture <b>1800 x 700 mm</b>	<b>C: 600 D: 350</b>	BAS18070TT	BAS18070BL	BAS18070DG	BAS18070GG	£770
Shower Tray Slate texture <b>1800 x 800 mm</b>	<b>C: 600 D: 400</b>	BAS18080TT	BAS18080BL	BAS18080DG	BAS18080GG	£838
Shower Tray Slate texture <b>1800 x 900 mm</b>	<b>C: 600 D: 450</b>	BAS18090TT	BAS18090BL	BAS18090DG	BAS18090GG	£915
Shower Tray Slate texture <b>2000 x 700 mm</b>	<b>C: 600 D: 350</b>	BAS20070TT	BAS20070BL	BAS20070DG	BAS20070GG	£959
Shower Tray Slate texture <b>2000 x 800 mm</b>	<b>C: 600 D: 400</b>	BAS20080TT	BAS20080BL	BAS20080DG	BAS20080GG	£1,046
Shower Tray Slate texture <b>2000 x 900 mm</b>	<b>C: 600 D: 450</b>	BAS20090TT	BAS20090BL	BAS20090DG	BAS20090GG	£1,104



### Standard Grating

Stainless steel grating  
130 x 130 mm  
Included in price.

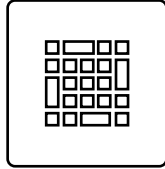

### BASE Grating

Stainless steel grating  
130 x 130 mm  
Finish must be chosen  
when ordering. Not inclu-  
ded on Shower tray price.

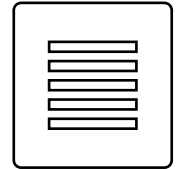

Grating is included on price of Shower tray.

Please select your colour/finish and add the code & price as per below:

Item Description A x B (mm)	Total White	Blanc	Dusty Grey	Graphite Grey	Retail Price (Exc VAT)
+BASGTBL/TT/DG/GG Powder coated grate matching shower tray colour. <b>Blanc, Total White, Dusty Grey &amp; Graphite Grey.</b>	 +BASGTTT	 +BASGTBL	 +BASGTDG	 +BASGTGG	<b>+£38</b>
+BASGTBB Metallic finished grate in <b>Brushed Brass</b> (BB)					<b>+£73</b>
+BASGTBS Metallic finished grate in <b>Brushed Steel</b> (BS)					<b>+£73</b>
+BASGTLB Metallic finished grate in <b>Light Bronze</b> (LB)					<b>+£73</b>
+BASGTDB Metallic finished grate in <b>Dark Bronze</b> (DB)					<b>+£73</b>



### Installation Kit

An installation kit specifically designed for BASE Shower trays are available as per request. Installation kits includes:

- **CLASSI Seal Flexible waterproof upstand** to guarantee full watertight conditions between your tiles and the shower tray.
- **SIKA PU Adhesive** 300 ml (2 tubes) for Shower tray installation. Polyurethane based adhesive must be used to guarantee a correct installation of the product.

### Installation kit Available

Shower Tray installation kit including **CLASSI Seal Flexible waterproof upstand & 2 PU Adhesive tubes 300 ml, SIKAFLEX**

BASKIT

+£ 99.00

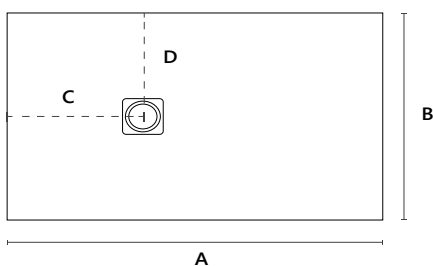

### PLEASE NOTE

The waste position vary depending on the Shower tray dimensions. Please follow the drawing and dimensions specified on "Drain position" on previous page to check the position of your waste.

**Waste position cannot be changed however Shower trays can be cut. For Shower Tray BESPOKE CUTTING please add BASCUT +£ 99.00 to prices above.**  
For any further enquiry, please contact us [sales@drenchshowers.co.uk](mailto:sales@drenchshowers.co.uk)

# Made to measure

DRENCH was born as a bespoke manufacturer.

From the most simplistic change in dimensions to the most complex shower enclosure we are happy to help.

Our manufacturing facilities in the UK give us the possibility to offer a full made to measure service in a timely and quality manner.

**Possibilities are endless.**

**Options below aimed to inspire your design as well as showing DRENCH's capabilities.**

Please collect as much detail as possible and contact us. DRENCH will always issue a bespoke quote and drawing for the items required to be confirmed or modify afterwards.

**Your specific needs are our ultimate goal.**

When dimensions or product configurations in this catalogue do not satisfy your requirements, please contact us on [sales@drenchshowers.co.uk](mailto:sales@drenchshowers.co.uk)

## Intermediate Dimensions



**All DRENCH items can be made to measure when requirements are out of standard dimensions and adjustments.**

For intermediate dimensions you can use 2 different rules to gage the bespoke price as long as height is standard (2100 mm): The rule of **Next size up** applies for intermediate widths when there is a next standard size up available. For example for a Fixed panel 970 mm width you can use Standard price of 1000 mm.

For different splits between Door and Inline for both Shower Door with Inline and Shower door hinged to Inline please **apply 15%** on top of standard price shown. For example a Shower Door with Inline 1200 mm is required but split must be 600 mm Door + 600 mm Inline panel.

**When the above rules are not applicable please contact us.**

## Floor to Ceiling



**All DRENCH products can be manufactured to be floor to ceiling if specified on the order.** We require distance between surfaces and we will supply enough adjustment for installation purposes.

**DRENCH Standard height is 2100 mm** and standard items are NOT considered floor to ceiling hence support bars are supplied. For heights between 2100 mm and 1900 mm Standard prices are applicable.

*For higher or lower height requirements as well as specific floor to ceiling needs, please contact us for a bespoke price.*



## Bespoke Colours & Finishes

## Full Bespoke Service



### **DRENCH is still the expert in colour matching.**

MATTE Colours are achieved with Architectural powder coating but our Metallic finishes are through anodising techniques.

DRENCH guarantees a 100% match in all RAL Classic colours. RAL Classic colours are identified with a four digit code and it can be found in most paint and coating suppliers specifications around the world. We reserve the right to decline specifications and orders in other RAL cards as RAL Design or RAL Effect when its match accuracy is doubtful or impossible.

*When RAL colour cannot be found or a particular metallic finish is required, contact us supplying as many details as possible of the colour or finish you are looking to achieve.*

### **With DRENCH products the only limitation is your imagination.**

From the most simplistic change in dimensions to the most complex shower enclosure we are happy to help. Our manufacturing facilities in the UK give us the possibility to offer a full made to measure service in a timely and quality manner.

We work with a recommended network of installers around the countries where DRENCH products are distributed that can assist on survey and installation.

*Please contact us on [sales@drenchshowers.co.uk](mailto:sales@drenchshowers.co.uk)*

# Accessories & Parts

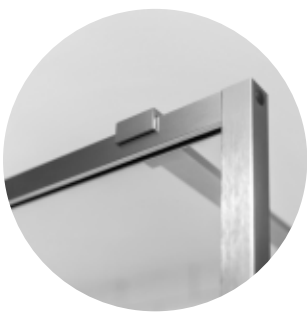

## **Support Bars**

Pages 15 -15

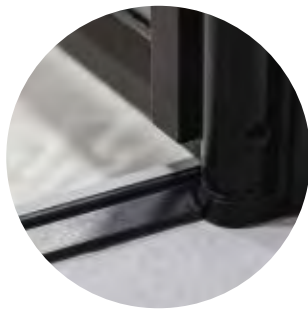

## **Seals**

Pages 15 -15

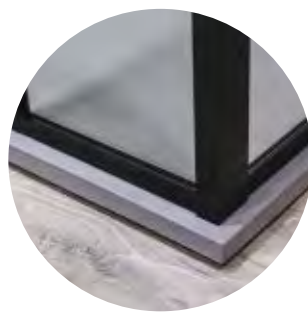

## **Extension Profiles**

Pages 15 -15









# Accessories & Parts

## Support Bars & Components

All DRENCH items include the required support bar when an order is placed. Please check item description specified on this catalogue to find out the support bar included on the item. Support Bars are also available as individual item to be purchased separately.

The below table shows suitability of each support bar available per product configuration:



Please do not hesitate to contact us if any doubt [sales@drenchshowers.co.uk](mailto:sales@drenchshowers.co.uk)

									
	Wall Fixed Panels	Wall Fixed Panels with Flipper	Free Standing Panels	Fixed Panel Combination	Single Doors & with Return	Door with Inline	Door hinged to Inline	Shower Enclosures	Bath Screens (Pivot & Fixed)
<b>FXSBCRS</b> Support Bar Across	✓ *For Units > 1000 mm width	✓	✓ *2 x FXSBCRS per panel	✗	✗	✗	✗	✓ *Only for Single Door + Return	✗
<b>FXSBNGL</b> 90° Angle Support Bar	✓ *From 400 to 500 mm width	✗	✗	✗	✗	✓ *For Units < 1000 mm width	✓ *For Units < 1000 mm width	✗	✓ *Optional for Fixed version
<b>FXSBPRL</b> Parallel Support Bar	✗	✗	✗	✗	✗	✓ *For Units > 1000 mm width	✓ *For Units > 1000 mm width	✗	✗
<b>FXSBDBL</b> Return Panel Support Bar	✗	✗	✗	✗	✗	✗	✗	✓ * For Door + Inline + Return	✗
<b>FXSBTBAR</b> T Shape Support Bar	✗	✗	✗	✓	✗	✗	✗	✗	✗

For EDGE Collection Semi-Frameless panels support bars please check page 22. For FRAME and HEXAGON collections support bars please check pages 28 and 32 respectively.





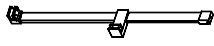
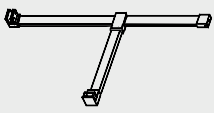

## Support Bars (Full Kit)

Please choose your Support Bar code required and add the two letter colour code to it.











Item Code	Description	Specification	Retail Price MATTE Colours (Exc VAT)	Retail Price Metallic Finishes (Exc VAT)
FXSBCRS..	<b>Support Bar Across</b> (3 Components, not pre-assembled) 1000 mm standard length, 30 x 10 mm bar		£119	£152
FXSBNGL..	<b>90° Angle Support Bar</b> (3 Components, not pre-assembled) 450 mm length, 30 x 10 mm bar **Not suitable for Panels wider than 1000 mm**		£99	NOT AVAILABLE
FXSBPRL..	<b>Parallel Support Bar</b> (4 Components, not pre-assembled) 2000 mm length, 30 x 10 mm bar		£161	£193
FXSBDBL..	<b>Return Panel Support Bar</b> (4 Components, not pre-assembled) 2000 mm length, 30 x 10 mm bar **Suitable for Shower Enclosures**		£161	£193
FXSBTBAR..	<b>T Shape Support bar</b> (4 components, not pre-assembled) 2x 30 x 10 mm bars. Long bar 1200 mm + Short bar at 1000 mm **Suitable for Shower Panels combinations**		£139	£235

Please email us at [sales@drenchshowers.co.uk](mailto:sales@drenchshowers.co.uk)

## Support Bars Components

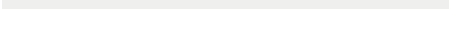
Item Code	Item Description	Specification	Retail Price <b>MATTE Colours</b> (Exc VAT)	Retail Price <b>Metallic Finishes</b> (Exc VAT)
<b>SB4..</b>	<b>Panel connector bracket</b> <i>Includes grub screws for installation</i> For Support Bars: FXSBCRS - Across support bar FXSBNGL - Angle Support Bar		£35	£43
<b>SB2&amp;SB3..</b>	<b>Wall connector bracket</b> <i>Includes grub screws &amp; wall fixing kit for installation</i> For Support Bars: FXSBCRS - Across support bar FXSBNGL - Angle Support Bar FXSBPRL - Parallel support bar FXSBDL - Return panel Support Bar		£32	£42
<b>SB14..</b>	<b>Inline Panel connector bracket</b> <i>Includes grub screws for installation</i> For Support Bars: FXSBPRL - Parallel support bar FXSBDL - Return panel Support Bar		£45	£56
<b>SB15..</b>	<b>Return Panel connector bracket</b> <i>Includes grub screws for installation</i> For Support Bars: FXSBDL - Return panel Support Bar		£36	£42
<b>BAR100..</b>	<b>Aluminium bar 30 x 10 x 1000 mm</b> <i>1000 mm total length</i>  **Suitable for ALL SUPPORT BAR options**		£52	£62
<b>BAR200..</b>	<b>Aluminium bar 30 x 10 x 2000 mm</b> <i>2000 mm total length</i>  **Suitable for ALL SUPPORT BAR options**		£102	£115

### MATTE Colours available

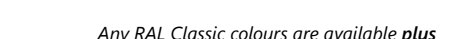
	BK	<b>Matt Black</b>
	GG	<b>Graphite Grey</b>
	GM	<b>Gun Metal</b>
	BO	<b>Burnt Orange</b>
	LY	<b>Lemon Yellow</b>
	PP	<b>Pale Pink</b>
	BL	<b>Blanc</b>
	TT	<b>Total White</b>
	MI	<b>Mint</b>
	FO	<b>Forest</b>
	CB	<b>Capri Blue</b>
	GN	<b>Grey Navy</b>

Any RAL Classic colours are available *plus* 35% to prices above.

### Metallic Finishes available

<b>Light Bronze</b>	Anodised	LB
<b>Dark Bronze</b>	Anodised	DB
<b>Brushed Steel</b>	Anodised	BS
<b>Brushed Brass</b>	Anodised	BB

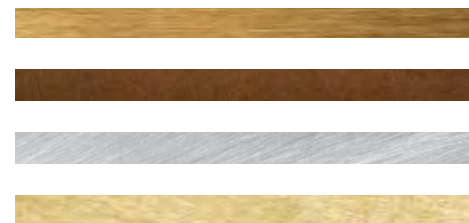

# Accessories & Parts

## Shower Door Seals & Thresholds

All DRENCH items include the required seal and components (threshold bit) to guarantee a watertight installation.

It is important to follow DRENCH assembly instructions to make sure both seal and threshold work properly.

Sometimes components get damaged or lost during the installation so both Seals and Threshold bits are available to be purchased separately.

Please contact us if any doubt; [sales@drenchshowers.co.uk](mailto:sales@drenchshowers.co.uk)



## Seals for Bath Screens, Flipper Panels & Shower Doors

Item Code	Description	Specification	Retail Price MATTE Colours (Exc VAT)	Retail Price Metallic Finishes (Exc VAT)
SEALBAT	<b>Rubber Seal for Pivot Bath Screen</b> **PLEASE SPECIFY VISIBLE GLASS BEFORE ORDERING**		£22	£22
SEALFLIP	<b>Rubber Seal for Flipper Panel</b> **PLEASE SPECIFY VISIBLE GLASS BEFORE ORDERING**		£12	£12
SEALDOR	<b>Rubber Seal for Door (Single or paired with Inline panel)</b> **PLEASE SPECIFY VISIBLE GLASS BEFORE ORDERING**		£22	£22

Please email us at [sales@drenchshowers.co.uk](mailto:sales@drenchshowers.co.uk)

## Installing DRENCH Seals

Open your door, bath panel or flipper panel fully.

Underneath the bottom profile you should find 2 grooves that go from the closing post to the hinge profile.

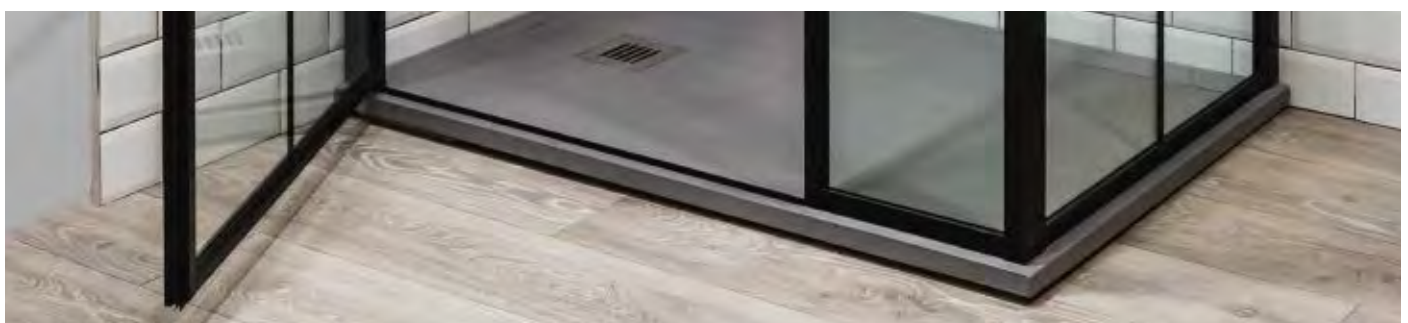
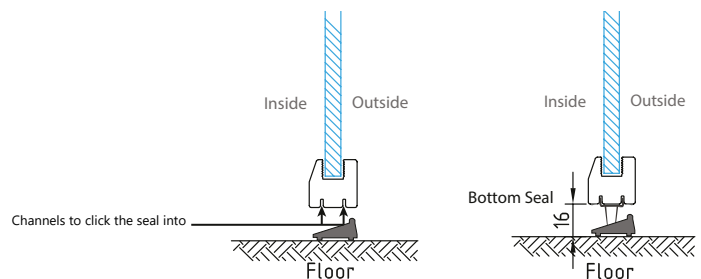

Please click the seal into these grooves and make sure the whole piece is clicked in along the profile.







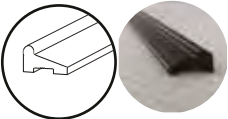
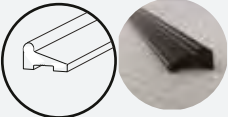
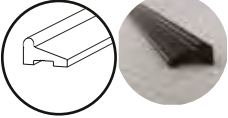







## Threshold bit for Shower Doors

To guarantee a watertight installation DRENCH Shower doors include a threshold bit to be stuck to your shower tray or wet room floor in order to stop the water running out the shower area. Threshold bit is included on all doors but sometimes components get damaged or lost during installation so they can be purchased separately.

**Please note threshold is made of aluminium and matches the colour/finishes of your shower door. Please add the two digits code to have your threshold in the right colour/finish.**

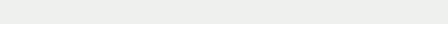



Item Code	Item Description	Specification	Retail Price <b>MATTE Colours</b> (Exc VAT)	Retail Price <b>Metallic Finishes</b> (Exc VAT)
THR <b>DOR70L</b> THR <b>DOR70R</b>	<b>Threshold bit for Shower Door (700 mm width)</b> <i>Please note this item is handed L: Left // R: Right</i>		£28	£36
THR <b>DOR76L</b> THR <b>DOR76R</b>	<b>Threshold bit for Shower Door (760 mm width)</b> <i>Please note this item is handed L: Left // R: Right</i>		£28	£36
THR <b>DOR80L</b> THR <b>DOR80R</b>	<b>Threshold bit for Shower Door (800 mm width)</b> <i>Please note this item is handed L: Left // R: Right</i>		£28	£36
THR <b>DOR90L</b> THR <b>DOR90R</b>	<b>Threshold bit for Shower Door (900 mm width)</b> <i>Please note this item is handed L: Left // R: Right</i>		£28	£36

### MATTE Colours available

	BK	<b>Matt Black</b>
	GG	<b>Graphite Grey</b>
	GM	<b>Gun Metal</b>
	BO	<b>Burnt Orange</b>
	LY	<b>Lemon Yellow</b>
	PP	<b>Pale Pink</b>
	BL	<b>Blanc</b>
	TT	<b>Total White</b>
	MI	<b>Mint</b>
	FO	<b>Forest</b>
	CB	<b>Capri Blue</b>
	GN	<b>Grey Navy</b>

Any RAL Classic colours are available *plus* 35% to prices above.

### Metallic Finishes available

	<b>Light Bronze</b>	Anodised	LB
	<b>Dark Bronze</b>	Anodised	DB
	<b>Brushed Steel</b>	Anodised	BS
	<b>Brushed Brass</b>	Anodised	BB



# Accessories & Parts

## Extension & Spare Profiles

All DRENCH items will always include the required profiles for installation. These profiles are also available as individual items when dimensions on site are slightly out (extended wall channels) or when panels need to be used together (corner channel).

Please note each item shows an **adjustment range** on this catalogue which is important to take into consideration before ordering. The adjustment range gives a minimum and a maximum point.

Please do not hesitate to contact us if any doubt [sales@drenchshowers.co.uk](mailto:sales@drenchshowers.co.uk)

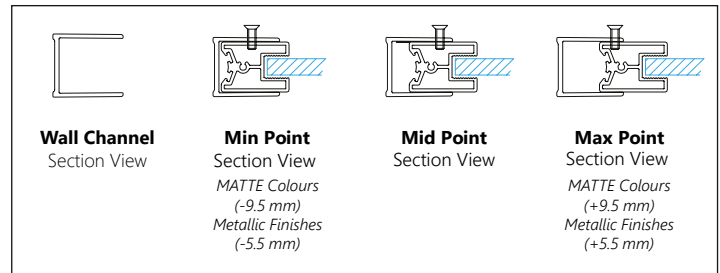

Item Code	Description	Specification	Retail Price MATTE Colours (Exc VAT)	Retail Price Metallic Finishes (Exc VAT)
PREXT145..	<b>Extended Wall Channel (+/- 14.5 mm Adjustment)</b> <i>Deeper wall channel to extend shower unit width.</i>		£144	£178
PREXT400..	<b>Extended Wall Channel (+40 mm on width)</b> <i>Box Section to extend shower unit width.</i>		£157	£192
PR758..	<b>Corner Channel</b> <i>Profile to combine 2 panels together for L-Shape configurations &amp; Shower Enclosures.</i>		£128	£213

Please if customer is unsure on new adjustment with any of the above profiles email us at [sales@drenchshowers.co.uk](mailto:sales@drenchshowers.co.uk)

### MATTE Colours available

	BK	<b>Matt Black</b>	<b>Light Bronze</b>	Anodised	LB
	GG	<b>Graphite Grey</b>	<b>Dark Bronze</b>	Anodised	DB
	GM	<b>Gun Metal</b>	<b>Brushed Steel</b>	Anodised	BS
	BO	<b>Burnt Orange</b>	<b>Brushed Brass</b>	Anodised	BB
	LY	<b>Lemon Yellow</b>			
	PP	<b>Pale Pink</b>			
	BL	<b>Blanc</b>			
	TT	<b>Total White</b>			
	MI	<b>Mint</b>			
	FO	<b>Forest</b>			
	CB	<b>Capri Blue</b>			
	GN	<b>Grey Navy</b>			

### Metallic Finishes available

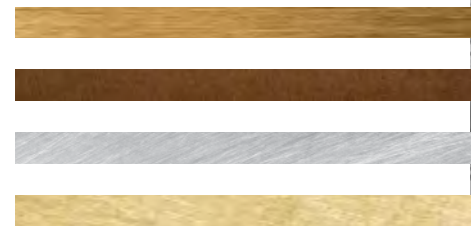

Any RAL Classic colours are available plus 35% to prices above.



# Maintenance & Cleaning

## Profiles & Aluminium Frames

The best method of cleaning is using a **mild detergent solution with warm water**. A sponge or soft cloth should be used and nothing should be harsher than natural bristle brushes.

## Glass

There is an **Easy Clean coating** to the internal face of the glass only.

Please be advised that on occasions there may be mist to this face. This can be easily removed with a dry, lint free cloth. For daily cleaning we recommend to use a conventional glass cleaner and a squeegee, especially for the internal side.



**We recommend regularly wiping your product with a lint free soft cloth.**



**You may like to use a squeegee to remove water splash.**



**Should you wish to use a bathroom cleaner, it should be a mild detergent only and ensure it is rinsed thoroughly with clean water.**



**Never use any solvents, abrasive cleaners or cloths or anything containing bleach.**



# Warranty Terms & Conditions

## WARRANTY TERMS

DRENCH products have warranty against faulty materials or workmanship. Shower Panels, Doors and Enclosures in Metallic Finishes have lifetime warranty. Shower Trays and Shower Panels, Doors and Enclosures in Matte colours or RAL options have 5 years warranty.

The following rules apply:

- \* Proof of purchase in the form a receipt or invoice is required in order to validate the guarantee.
- \* In the event that a product is faulty the defect must be notified to our technical department within 30 days of the fault happening. (sales@drenchshowers.co.uk)  
The product has been purchased in one of our authorised stockist for normal domestic use and it was not purchased as ex-showroom display.
- \* The product has not been handled carelessly or misused and has not been wilfully damaged, neglected or used in abnormal conditions.
- \* The product has not been modified, altered or transformed in any way.

## TERMS & CONDITIONS

### Definitions

1. "Company" means DRENCH EUROPE LTD.
2. "Customer" means customer of the Company.
3. "Conditions" means the below conditions of sale.
4. "Contract" means any contract entered into for the sale of goods by the Company to the Customer.
5. "Goods" means any Goods the subject of any contract and shall include any part or parts of them and materials incorporated in them.
6. "Standard Items" means any item included in this pricelist with an specific description of size, colour and configuration.
7. "Bespoke" or "Made to measure items" mean any item manufactured as per customer request. items in any specific RAL colour or a Glass option are considered "Bespoke" despite size or configuration.
8. "Carrier" the company person or persons with the object of delivering the Goods to the Customer.

### TERMS & CONDITIONS OF SALE:

1. All orders are subject to these Conditions unless otherwise agreed. All goods are subject to availability. If you do not understand any of the following please email us at sales@drenchshowers.co.uk or telephone +44 (0) 2380274945.
2. These Conditions represent the entire Conditions of sale and nothing shall operate to in any way alter or vary the Conditions without the prior approval of DRENCH EUROPE LTD.
3. These conditions shall apply to all contracts to the exclusion of all other conditions express or implied by statute or otherwise to the extent as is permissible by law.
4. Acceptance of Goods by the Customer shall be conclusive evidence before any Court of Arbitrator that these Conditions apply. DRENCH EUROPE LTD reserves the right to change the Conditions without prior notice. Customers are advised to check for any variations to the Conditions before an order.

### PRODUCTS:

1. All items sold are brand new products and are supplied complete with full manufacturers guarantee.
2. All items are delivered with fixings and instructions for installation.

- \* The guarantee will not apply in the event of any repair if DRENCH EUROPE LTD had not been informed accordingly and it was not carried out under DRENCH EUROPE LTD authorisation/supervision.
- \* The guarantee will not apply if installation, use and maintenance has not been carried out in accordance with DRENCH EUROPE LTD installation instructions.
- \* Damages and breakage of glass are not covered by the guarantee as all glass is used by DRENCH EUROPE LTD conforms to EN12150-1.
- \* Fair wear and tear of the product and lime scale and mildew are excluded from the guarantee.
- \* Seals, subject to wear and tear are guaranteed only for a period of 12 months.
- \* Labour cost are not covered under guarantee unless specifically authorised in writing by DRENCH EUROPE LTD.
- \* The benefit of this guarantee cannot be assigned.

3. It is very important that both installation and assembly of DRENCH products are performed by qualified professionals and according to instructions supplied.

All images, specifications and advertising on our website are for the sole purpose of giving an approximate description of the goods. We advise customers to seek technical advice from qualified sources prior to ordering including any installation work that may be required.

### PRICES:

All prices featured in this pricelist are Recommended Retail Prices excluding VAT. DRENCH EUROPE LTD does not accept liability for any mistake or calculation error made when drawing up a quotation.

### ORDERS:

Orders may be placed via distributor, agent, sales representative or directly submitted to our Commercial Department. A written format may be required when placing an order. DRENCH EUROPE LTD do not accept orders via phone or any other means than email. DRENCH EUROPE LTD reserves the right to refuse any order. Orders are accepted on the basis the Customer has read and accepted these conditions.

### CANCELLATIONS & MODIFICATIONS:

No order cancellation or modification will be accepted once the manufacturing process has started. In any event, there is a max period of 24 hours after receipt of order confirmation to ask for any cancellation or modification.

To exercise your right of cancellation within 24 hours you must give written notice by email giving details of goods ordered. Orders can only be cancelled once the Company confirms cancellation to the Customer.

### DELIVERY:

Please check all deliveries for damages or discrepancies within 48 hours from receiving the goods. Claims for damaged goods must be notified to DRENCH EUROPE LTD by email stating any damages and/or defects of the goods received from the courier. Claims for damaged goods must be notified to DRENCH EUROPE LTD by email stating any damages and/or defects of the goods received from the courier.

- \* The guarantee does not cover any further right than those expressed and it does not cover any claim for consequential loss or damage.
- \* This guarantee is offered as an extra benefit and does not affect your statutory right as a consumer in any way whatsoever.
- \* In the event of a claim under our guarantee, a site visit is required which will be chargeable. This will be refunded in the event that the product is defective or manufactured incorrectly.
- \* In the event that DRENCH products are used for Steam or sauna room installations, it must be specified at the point of ordering. Our products in these environments carry a 2 year warranty.
- \* In the event that a replacement product is required and the product is not longer available, DRENCH EUROPE LTD will replace it with the nearest available product.

Unless we have notification within this period, we have no claim against the courier and therefore we will not be liable for any claim made against our company. Please note that all items must be removed from the packaging and checked within the above time scale.

### RETURN POLICY:

Should you wish to return any items to us, the return of the goods must be done subject to the following conditions:

1. The return of Goods will only be admitted when it has been accepted and communicated accordingly by the Company.
2. The return of Goods will only be admitted with the condition as new, in the packaging provided and all components supplied initially.
3. Bespoke and made to measure products as well as RAL colours and Glass Options are non returnable.
4. The Goods must not have been installed or attempted to be installed.
5. Customers are responsible for obtaining proof of delivery and receipt of returned goods. It is the Customer responsibility to ensure the goods reach us in good condition.

### RETENTION OF TITLE:

1. The goods shall be at the Buyer's risk as from delivery. 1.2 In spite of delivery having been made, property of the Goods shall not pass from the Seller until: 1.2.1 the buyer shall have paid the Price in full; and 1.2.2 no other sums of any kind shall be due from the buyer to the seller.

### PAYMENT CONDITIONS:

Payments can be made by BACS transfer according to sales terms agreed. In the event of outstanding payments, the Company will not dispatch any goods.

### DIVISIBILITY CLAUSE:

This contract is divisible. Each delivery made hereunder; 1) shall be deemed to arise from a separate contract and 2) shall be invoiced separately and any invoice for a delivery shall be payable in full accordance with the terms of payments for herein without reference to and notwithstanding any defect of default in delivery of any other instalment.



# DRENCH

I N S P I R E B Y D E S I G N

Unit 5 & Deer Park Farm, Hursley Road,  
Hursley, SO21 2LD

[sales@drenchshowers.co.uk](mailto:sales@drenchshowers.co.uk)

+44 (0) 2380 274 945

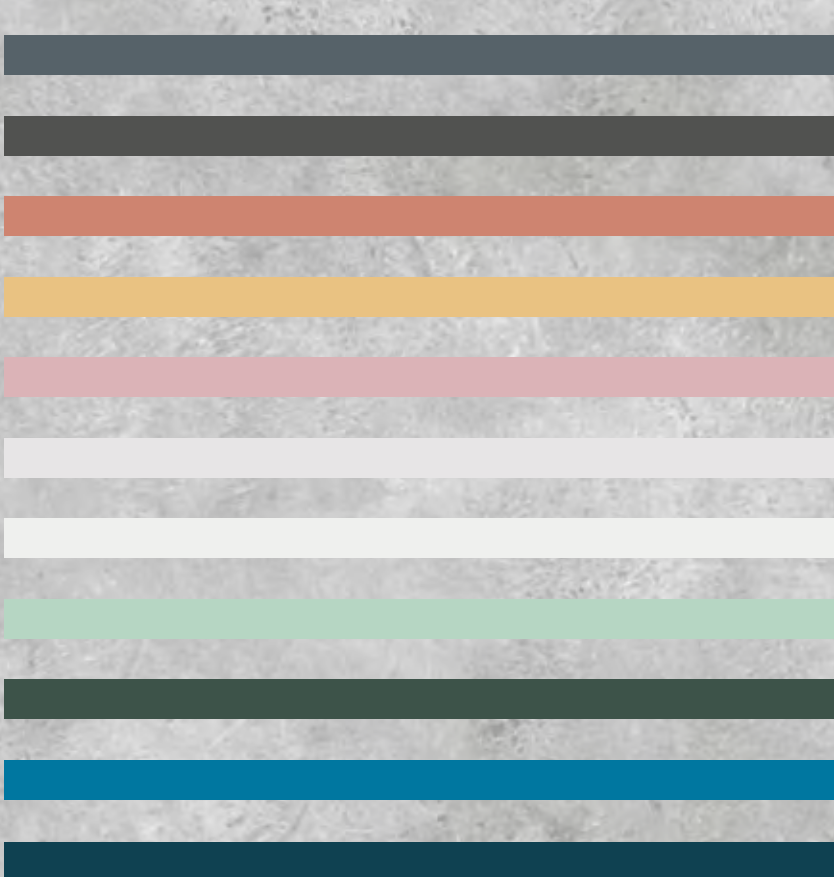

[www.drenchshowers.co.uk](http://www.drenchshowers.co.uk)